

5813



Digital Color Copier/Printer

When ordering supplies or requesting service for your copier, you will need to provide the model and serial number of your machine.

Please take a moment to enter your model and serial numbers here.

MODEL NUMBER: _____

SERIAL NUMBER: _____

To order supplies, call: () _____

To request service, call: () _____



Customer Vision® -
Our commitment to your
complete satisfaction

Introduction

This manual contains detailed instructions on the operation and maintenance of this machine. To get maximum versatility from this machine all operators should carefully read and follow the instructions in this manual. Please keep this manual in a handy place near the machine.

Please read the Safety Information before using this machine. It contains important information related to USER SAFETY and PREVENTING EQUIPMENT PROBLEMS.



Notes:

Some illustrations might be slightly different from your machine.

Certain options might not be available in some countries. For details, please contact your local dealer.



Operator Safety:

This machine is considered a CDRH class I laser device, safe for office/EDP use. The machine contains a 15-milliwatt, 760-800 nanometer wavelength, GaAlAs laser diode. Direct (or indirect reflected) eye contact with the laser beam might cause serious eye damage. Safety precautions and interlock mechanisms have been designed to prevent any possible laser beam exposure to the operator.

Laser Safety:

The Center for Devices and Radiological Health (CDRH) prohibits the repair of laser-based optical unit in the field. The optical housing unit can only be repaired in a factory or at a location with the requisite equipment. The laser subsystem is replaceable in the field by a qualified Customer Engineer. The laser chassis is not repairable in the field. Customer engineers are therefore directed to return all chassis and laser subsystems to the factory or service depot when replacement or the optical subsystem is required.

Warning:

Use of controls or adjustment or performance of procedures other than those specified in this manual might result in hazardous radiation exposure.

Two kinds of size notation are employed in this manual. With this machine refer to the inch version.

For good copy quality, Lanier recommends that you use genuine Lanier toner.

Lanier shall not be responsible for any damage or expense that might result from the use of parts other than genuine Lanier parts in your Lanier office product.

Power Source:

120V, 60Hz, 16A

Please be sure to connect the power cord to a power source as above. For details about power source, ⇒ P.229 "Power Connection".

Note to users in the United States of America

Notice:

This equipment has been tested and found to comply with the limits for a Class B digital device, pursuant to Part 15 of the FCC Rules. These limits are designed to provide reasonable protection against harmful interference in a residential installation. This equipment generates, uses and can radiate radio frequency energy and, if not installed and used in accordance with the instructions, may cause harmful interference to radio communications. However, there is no guarantee that interference will not occur in a particular installation. If this equipment does cause harmful interference to radio or television reception, which can be determined by turning the equipment off and on, the user is encouraged to try to correct the interference by one more of the following measures:

Reorient or relocate the receiving antenna.

Increase the separation between the equipment and receiver.

Connect the equipment into an outlet on a circuit different from that to which the receiver is connected.

Consult the dealer or an experienced radio /TV technician for help.

Warning

Changes or modifications not expressly approved by the party responsible for compliance could void the user's authority to operate the equipment.

Note to users in Canada

Note:

This Class B digital apparatus complies with Canadian ICES-003.

Remarque concernant les utilisateurs au Canada

Avertissement:

Cet appareil numérique de la classe B est conforme à la norme NMB-003 du Canada.

In accordance with IEC 60417, this machine uses the following symbols for the main power switch:

I means **POWER ON**.

⏻ means **STAND BY**.

Notice

Do not make copies of any item for which copying is prohibited by law.

Copying the following items is normally prohibited by local law:

Bank bills, revenue stamps, bonds, stock certificates, bank drafts, checks, passports, driver's licenses.

The color copy samples in this book may differ slightly from the actual copies due to printing effects.

The color on each Color key may differ slightly from that of the actual copy.

This machine is equipped with a function that prevents making counterfeit bank bills. Due to this function the original images similar to bank bills may not be copied properly.

Safety Information

When using your equipment, the following safety precautions should always be followed.

Safety During Operation

In this manual, the following important symbols are used:

⚠ WARNING:
Indicates a potentially hazardous situation which, if instructions are not followed, could result in death or serious injury.

⚠ CAUTION:
Indicates a potentially hazardous situation which, if instructions are not followed, may result in minor or moderate injury or damage to property.

⚠ WARNING:

- **Connect the power cord directly into a wall outlet and never use an extension cord.**
- **Disconnect the power plug (by pulling the plug, not the cable) if the power cable or plug becomes frayed or otherwise damaged.**
- **To avoid hazardous electric shock or laser radiation exposure, do not remove any covers or screws other than those specified in this manual.**
- **Turn off the power and disconnect the power plug (by pulling the plug, not the cable) if any of the following conditions exists:**
 - **You spill something into the equipment.**
 - **You suspect that your equipment needs service or repair.**
 - **Your equipment's cover has been damaged.**
- **Do not incinerate spilled toner or used toner. Toner dust might ignite when exposed to an open flame.**
- **Disposal can take place at our authorized dealer or at appropriate collection sites.**
- **Dispose of the used toner cartridge in accordance with the local regulation.**

⚠ CAUTION:

- *Protect the equipment from dampness or wet weather, such as rain, snow, and so on.*
- *Unplug the power cord from the wall outlet before you move the equipment. While moving the equipment, you should take care that the power cord will not be damaged under the equipment.*
- *When you disconnect the power plug from the wall outlet, always pull the plug (not the cable).*
- *Do not allow paper clips, staples, or other small metallic objects to fall inside the equipment.*
- *Keep toner (used or unused) and toner cartridge out of the reach of children.*
- *For environmental reasons, do not dispose of the equipment or expended supply waste at household waste collection points. Disposal can take place at an authorized dealer or at appropriate collection sites.*
- *The inside of the machine could be very hot. Do not touch the parts with a label indicating the "hot surface". Otherwise it could cause a personal burn.*
- *Our products are engineered to meet high standards of quality and functionality, and we recommend that you only use the expendable supplies available at an authorized dealer.*

ENERGY STAR Program

ENERGY STAR®

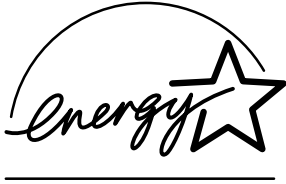

As an ENERGY STAR Partner, we have determined that this machine model meets the ENERGY STAR Guidelines for energy efficiency.

The ENERGY STAR Guidelines intend to establish an international energy-saving system for developing and introducing energy-efficient office equipment to deal with environmental issues, such as global warming.

When a product meets the ENERGY STAR Guidelines for energy efficiency, the Partner shall place the ENERGY STAR logo onto the machine model.

This product was designed to reduce the environmental impact associated with office equipment by means of energy-saving features, such as Low-power mode.

- **Low Power Mode**

This product automatically lowers its power consumption 15 minutes after the last copy or print job has finished. Printing is still possible in Low Power Mode, but if you wish to make copies press the **[Energy Saver]** key first.

For details about how to change the default interval, see "Energy Saver Level" ⇒ P.213 "System settings".

- **Auto Off Mode(Copier only)**

To conserve energy, this product automatically turns off 90 minutes after the last copying or printing job has been completed. Printing is available in this mode, but if you use the copier, press the operation switch.

For details about how to change the default interval, see "Auto Timer" ⇒ P.213 "System settings".

- **Sleep Mode(Printer installed)**

If the printer features are installed, this product automatically lowers its power consumption even further 90 minutes after the last copy or print job has finished. Printing is still possible in Sleep Mode, but if you wish to make copies press the operation switch first.

For details about how to change the default interval, see "Auto Timer" ⇒ P.213 "System settings".

Specification

		Copier only	Printer installed
Low Power Mode	Power consumption	190 W	230 W
	Default interval	15 minutes	15 minutes
	Recovery Time	320 sec.	320 sec.
Auto Off Mode	Power consumption	15 W	--
	Default interval	90 minutes	--
Sleep Mode	Power consumption	--	45 W
	Default interval	--	90 minutes

Recycled Paper

In accordance with the ENERGY STAR Program, we recommend use of recycled paper which is environment friendly. Please contact your sales representative for recommended paper.

How to Read this Manual

Symbols

In this manual, the following symbols are used:

WARNING:

This symbol indicates a potentially hazardous situation that might result in death or serious injury when you misuse the machine without following the instructions under this symbol. Be sure to read the instructions, all of which are described in the Safety Information section.

CAUTION:

This symbol indicates a potentially hazardous situation that might result in minor or moderate injury or property damage that does not involve personal injury when you misuse the machine without following the instructions under this symbol. Be sure to read the instructions, all of which are described in the Safety Information section.

The statements above are notes for your safety.

Important

If this instruction is not followed, paper might be misfed, originals might be damaged, or data might be lost. Be sure to read this.

Preparation

This symbol indicates the prior knowledge or preparations required before operating.

Note

This symbol indicates precautions for operation, or actions to take after misoperation.

Limitation

This symbol indicates numerical limits, functions that cannot be used together, or conditions in which a particular function cannot be used.

Reference

This symbol indicates a reference.

[]

Keys that appear on the machine's panel display.

[]

Keys built into the machine's operation panel.

TABLE OF CONTENTS

What You Can Do with This Machine	2
Guide to Components	4
Options	6
Operation Panel	7
Using the Touch Panel Display	9
Selecting Functions	9
Entering Numbers	10
Color Sample Chart	11

1. Basics

Turning On the Power	13
Turn on the Main Power	13
Starting the Machine	14
Originals	16
Standard Size Originals	16
Recommended Originals	16
Non-recommended Originals for the Document Feeder	17
Placing Originals on the Exposure Glass	18
Loading a Stack of Originals in the Document Feeder	19
Loading one Original at a Time in the Document Feeder	21
Loading Originals of Different Sizes in the Document Feeder	23
Placing Custom Sized Originals	24
Removing the Platen Cover to Copy a Large Original	26

2. Copying

Basic Procedure	27
Adjusting Copy Image Density	28
Selecting a Color Mode	30
Twin Color Mode	34
Selecting the Original Image Type	36
Selecting the Copy Paper Size	39
Copying from the Bypass Tray	41
Auto Reduce/Enlarge	51
Energy Saver Mode	52
Auto Off Mode	52
Interrupt Copying	53
Auto Start	54
Recall	54
Program	55
Check Modes	57
Counter	57

Reduce/Enlarge	58
Preset R/E	58
Zoom	60
Size Magnification	61
Directional Magnification (%)	63
Directional Size Magnification (inch)	64
Poster Mode	66
Duplex.....	69
1 Sided → 2 Sided	69
2 Sided → 2 Sided	72
Book → 2 Sided	73
Multi → 2 Sided.....	74
Series Copies.....	76
Book → 1 Sided	76
2 Sided → 1 Sided	78
Combine	79
Combine 2 Originals.....	79
Combine 4 Originals.....	81
Shifting the Image	82
Shift	82
Margin Adjustment	83
Erase.....	86
Center Erase	86
Border Erase	86
Center/Border Erase	87
Cover Sheet.....	89
Front Cover	89
Front & Back Cover.....	91
Color Creation.....	94
Color Conversion	94
Color Erase	96
Color Background	97
Type Mask.....	99
Image Creation.....	101
Outline Image.....	101
Shadow Image.....	102
Slanted Image.....	106
Mirror Image.....	108
Repeat Image.....	109
Positive/Negative	114
Finishing.....	116
Sort.....	116
Stack	117
Staple	118
Combination Chart	121

3. Image Overlay (Option)

What is Image Overlay?	125
Edit Background	128
Color/Image Adjustment.....	128
Color Creation	129
Basic Settings	130

4. Adjustment and Color Memory





Color Balance	131
Color Balance Adjustment.....	131
Color Balance Program.....	132
Color Balance Sample	134
Color Adjustment	140
Image Adjustment	142
Soft/Sharp, Contrast, Background Density, and Pastel	143
U.C.R. Adjustment, A.C.S. Sensitivity and Text/Photo Sensitivity	144
Program User Color	145
Adjusting Colors Based on the Selected Color	145
Mixing Colors Manually with the Number Keys.....	147
Sampling the User Colors	149

5. Area Editing (Option)

What is Area Editing?	151
How to Edit Areas	152
Designating Areas	153
Designate Area Display.....	154
Designate Area Tools.....	155
Area Shapes	156
Frame/Line	160
Notes for Designating Areas	163
Selecting Modes for Designated Areas	165
Area Editing.....	167
Delete Area	168
Save Area	169
Frame/Line	170
Selecting Modes for Outside Designated Areas	171
Area Shapes	172
Changing Basic Settings for the Entire Image	174
Checking and Changing Areas	176
Change Modes.....	176
Adding Areas.....	178
Erasing an Area	179
Erasing a Group.....	180

Exiting Area Editing	181
Combination Chart for Area Editing	182

6. Troubleshooting

If Your Machine Does not Operate as You Want	187
If You Cannot Make Copies as You Want.....	189
 Loading Paper.....	192
Non-recommended Paper for Paper Trays	192
Loading Paper in the Paper Tray	193
Loading Paper in the Large Capacity Tray.....	194
 Changing The Toner Cartridge.....	196
 Clearing Misfeeds.....	198
Check the Misfeed Location Display	198
Clearing Paper Misfeeds.....	199
 Adding Staples	201
 Removing Jammed Staples.....	203

7. Changing the Machine's Settings

Changing Paper Size.....	207
1 st Tray Paper Size	207
2 nd and 3 rd Tray Paper Size.....	209
Changing Paper Size with the User Tools	209
User Tools.....	211
Accessing the User Tools	211
Exiting from the User Tools.....	212
Setting You can Change with the User Tools (System Settings).....	213
Settings You can Change with the User Tools (Copier Features)	217

8. Others

Do's and Don'ts	227
Where to Put Your Machine.....	228
Machine Environment	228
Power Connection.....	229
Access to Machine.....	229
Maintaining Your Machine.....	230
Exposure Glass.....	230
Platen Cover	230
Document Feeder	231
Remarks	232
Copier.....	232





Use and Storage of Supplies	233
Copy Paper	233
Paper Storage	234
Toner Storage	234





9. Specification

Mainframe	235
Document Feeder (Option)	239
20-bin Sorter Stapler (Option)	240
Large Capacity Tray (LCT) (Option)	242
Multi-access	243
INDEX	245

What You Can Do with This Machine

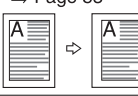
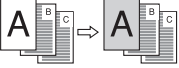
• Color Mode ⇒ Page 30





- Full Color Copy
 
- Black & White Copy
 
- Single Color Copy
 
- Twin Color Copy Color
 
- Red & Black
 

- Shift ⇒ Page 82
 
- Margin Adjustment ⇒ Page 83
 
- Cover Sheet ⇒ Page 89 *2
 
- Center Erase ⇒ Page 87
 
- Border Erase ⇒ Page 87
 
- Center/Border Erase ⇒ Page 87
 

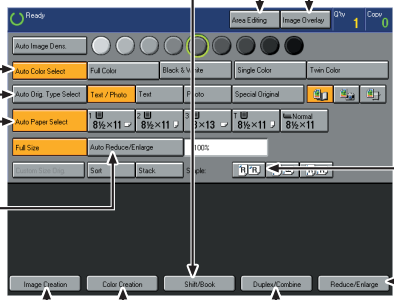
*1 Optional 20-bin sorter stapler is required.
 *2 Optional document feeder is required.
 *3 Optional editing kit is required.

- Auto Original Type Select ⇒ Page 36
- Auto Paper Select ⇒ Page 39
- Auto Reduce/Enlarge ⇒ Page 51

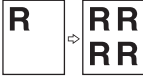

- Outline Image ⇒ Page 101
 
- Mirror Image ⇒ Page 108
 
- Shadow Image ⇒ Page 102
 
- Positive/Negative ⇒ Page 114
 
- Slanted Image ⇒ Page 106
 
- Repeat Image ⇒ Page 109
 

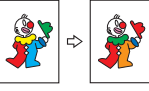
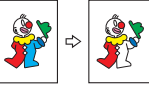
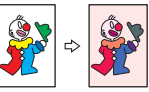
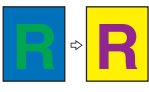
- Color Conversion ⇒ Page 94
 
- Color Erase ⇒ Page 96
 
- Color Background ⇒ Page 97
 
- Type Mask ⇒ Page 99
 

•Area Editing ⇒ Page 151 *3

• Color Conversion
⇒ Page 166 *3



• Color Background
⇒ Page 166 *3



• Delete Area
⇒ Page 168 *3



• Image Overlay
⇒ Page 125 *3

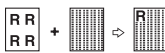

• Color Erase ⇒ Page 166 *3



• Paint ⇒ Page 166 *3

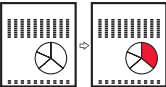

• Save Area ⇒ Page 169 *3



• Sort ⇒ Page 116 *1



• Stack ⇒ Page 117 *1



• Staple ⇒ Page 118 *1

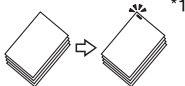

• Preset R/E ⇒ Page 58



• Directional Magnification(%)
⇒ Page 63

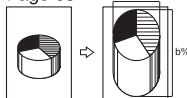

• Zoom ⇒ Page 60



• Directional Size Magnification(inch) ⇒ Page 64

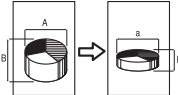

• Size Magnification ⇒ Page 61



• Poster Mode ⇒ Page 66



• 1 Sided → 2 Sided
⇒ Page 69

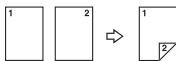

• 2 Sided → 2 Sided
⇒ Page 72



• Book → 1 Sided
⇒ Page 76

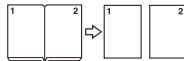

• 2 Sided → 1 Sided
⇒ Page 78

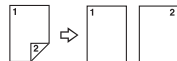

• Book → 2 Sided
⇒ Page 73

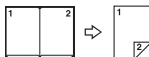

• Multi → 2 Sided
⇒ Page 74

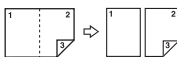

• Combine 2 Originals
⇒ Page 79 *2



• Combine 4 Originals
⇒ Page 81 *2



Guide to Components

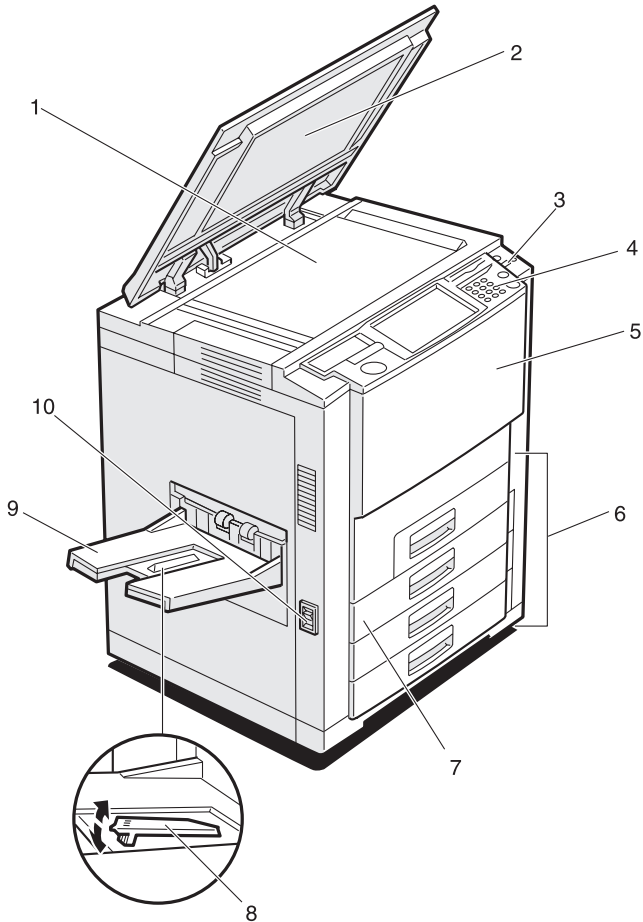

TCAH010E

1. Exposure glass

Position originals here face down for copying.

2. Platen cover (option)

Lower this cover over originals placed on the exposure glass for copying.

3. Operation switch

Press this switch to turn the power on (the **On** indicator goes on). To turn off the power off, press this switch again (the **On** indicator goes off).

4. Operation panel

⇒ P.7 "Operation Panel".

5. Front cover

Open to access the inside of the machine.

6. Paper tray

Set paper here. ⇒ P.192 "☰ Loading Paper".

7. Auto duplex tray

Use to make two-sided copies.

8. Stopper

When you copy onto thin paper, raise this to prevent curling.

9. Copy tray

Completed copies are delivered here.

10. Main power switch

To start the machine, turn on this switch.

Note

- If the machine does not operate after turning on the operation switch, check if the main power switch is turned on. If it is off, turn it on.

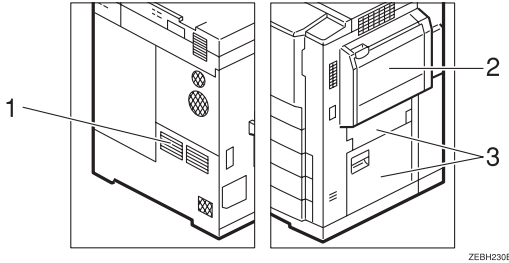

1. Ventilation hole

Prevents overheating. Do not obstruct the ventilation hole by placing or leaning an object near it. If the machine overheats, damage might occur.

2. Bypass tray

Use to copy onto OHP transparencies, adhesive labels, translucent paper, post cards, and custom size paper, ⇒ P.41 "Copying from the Bypass Tray".

3. Right side cover/Lower right cover

Open this cover to remove jammed paper.

Options

This machine can be provided with the following options:

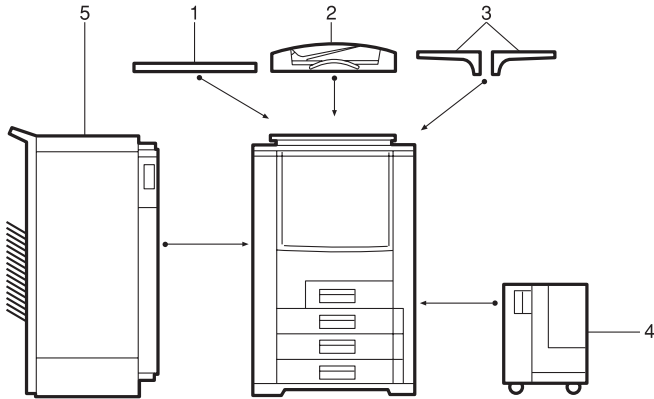

ZEBP210E

1. Platen cover

Lower this cover over originals placed on the exposure glass for copying.

2. Document feeder (ADF)

Insert a stack of originals here. They will be fed automatically.

3. Original tray

Place your originals.

Other Options:

- Embedded Controller Interface
- External Controller Interface
- Editing Kit

4. Large capacity tray (LCT)

Holds 1,500 sheets of paper.

Note

- The adapter is required for installation.

5. 20-bin sorter stapler

Sorts, stacks, and staples copies.

Operation Panel

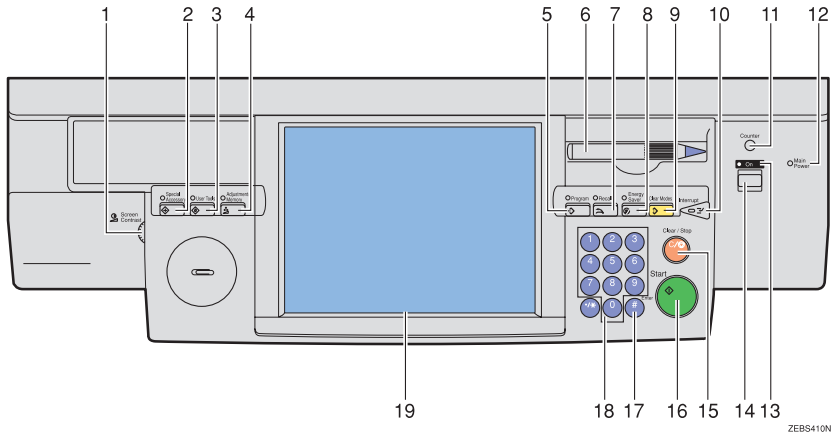

ZEB5410N

1. Screen Contrast knob

You can change the brightness of the display.

2. 【Special Accessory】 key

This key is not used for this machine.

3. 【User Tools】 key

Press to change the default setting. ⇒ P.211 “User Tools”.

4. 【Adjustment/Memory】 key

Press to adjust the image or color balance, or to make user colors. ⇒ P.131 “Adjustment and Color Memory”.

5. 【Program】 key

Press to select the program mode. ⇒ P.55 “Program”.

6. Editor pen (option)

Use to designate areas.

The editor pen is included in the optional editing kit.

7. 【Recall】 key

Press to recall the previously selected copy jobs.

8. 【Energy Saver】 key

Press to enter/exit the Energy Saver mode. ⇒ P.52 “Energy Saver Mode”.

9. 【Clear Modes】 key

Press to clear the previously entered settings.

10. 【Interrupt】 key

Press to make interrupt copies. ⇒ P.53 “Interrupt Copying”.

11. 【Counter】 key

Press to display the total number of copies made.

12. Main Power indicator

This indicator goes on when the main power switch is turned on, and goes off when the switch is turned off.

13. On indicator

This indicator goes on when the operation switch is turned on, and goes off when the switch is turned off.

14. Operation switch

Press this switch to turn the power on (the **On** indicator goes on). To turn the power off, press this switch again (the **On** indicator goes off).

15. [Clear/Stop] key

Press to cancel the copy number entered.
While copying, press to stop copying.
This key is also used to clear data.

16. [Start] key

Press to start copying.

17. [#] key

Press to enter data in selected modes.

18. Number keys

Use to enter the desired number of copies. They are also used to enter data.

19. Touch panel display

You can see the operation status and messages here.

Using the Touch Panel Display

Selecting Functions

On the touch panel display, you can find keys, instructions and messages. By pressing keys on the display, you can select or deselect functions, and enter data for the selected modes. If you make a mistake and wish to clear the current settings, press the **[Clear Modes]** key.

Important

- Do not apply a strong shock or force of about 30N (about 3kgf) or more to the panel display. Otherwise, the display might be damaged.

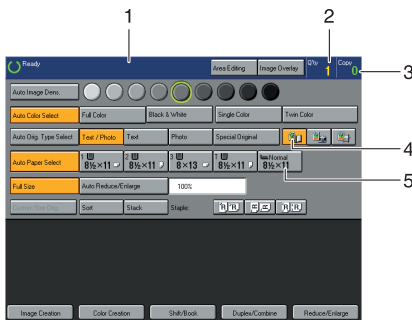

ZEBSS00N

1. Messages and instructions appear here.

2. Total number of copies to make

3. COPY COUNTER

Counts number of copies made so far.

Note

- You can select whether the copy counter counts up (counter up) or counts down (counter down). If you want to change the setting, ⇒ P.213 "System settings".

In this manual, keys on the display are indicated as follows:

Example:

- Key on the display: 
- In the manual: **[Auto Paper Select]** key

Note

- Do not press the touch panel display with any hard or sharp object.

4. Keys that have been selected.

5. Keys that have the option of being selected. Keys that do not have the option of being selected are fainter.

Entering Numbers

When the display prompts you to enter a number, type in the number with the number keys and press the [#] key on the display to accept it.

Should you make a mistake:

- If you have not pressed the [#] key yet, press the **[Clear]** key, and then re-enter it. If there is no **[Clear]** key on the display, press the **[Clear/Stop]** key.
- If you have already pressed the [#] key, press the item you wish to change on the display and re-enter the number with the number keys. Press the [#] key on the display to accept it.

Checking the functions you have selected

When you set one or more copy settings, the last item you selected will remain on the screen.



ZEBSS10N

1. [Check Modes] key

To check all the settings you have set so far, press the **[Check Modes]** key.

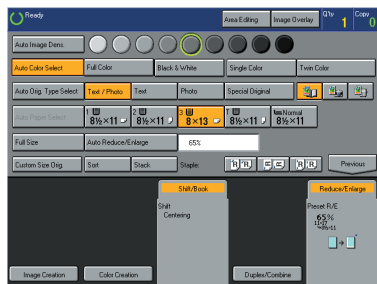
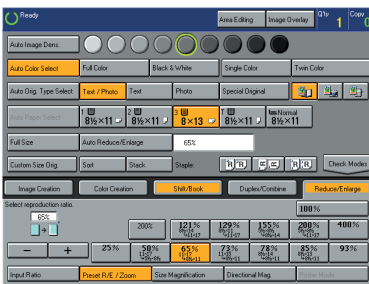

ZEBSS20N

Color Sample Chart

This is the User Color sample. You can mix the basic colors to make your own colors (User Color).

Note

- The color sample might differ somewhat from actual copies due to printing effects.

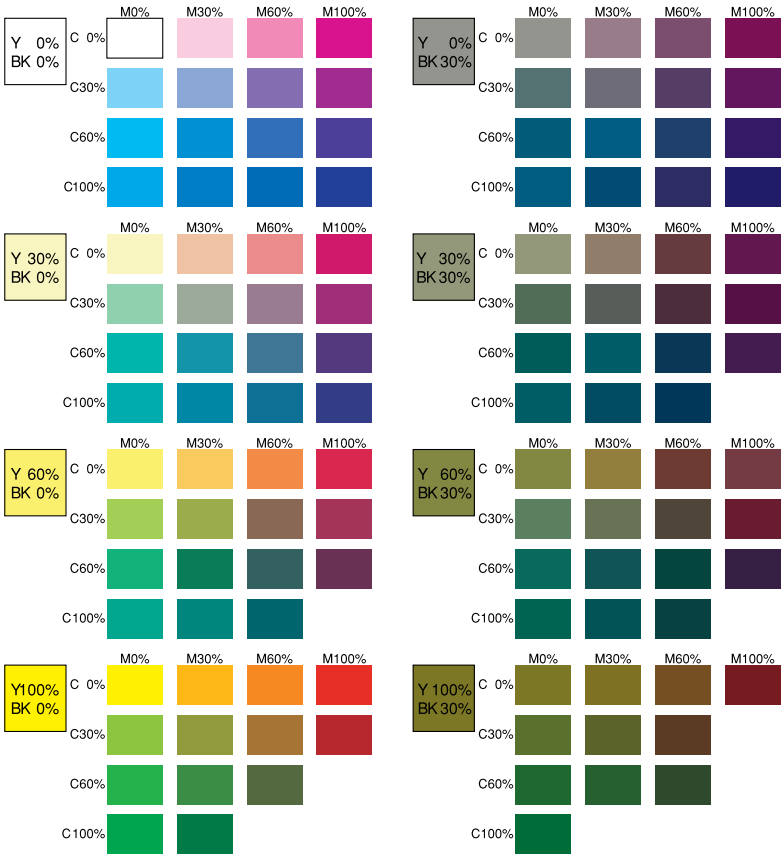

GCCLCT1E

Turning On the Power

To start the machine, press the operation switch to turn the power on.

Note

- This machine automatically enters Energy Saver mode or turns itself off if you do not use the machine for a while. For details, ⇒ P.52 "Energy Saver Mode", ⇒ P.213 "System settings".

Power Switches

This machine has an operation switch and main power switch.

❖ Operation switch (right side of the operation panel)

Press this switch to activate the machine. When the machine has warmed up, you can make copies.

❖ Main power switch (left side of the machine)

When the machine is not to be used for an extended period of time, turn off the main power switch.

Turn on the Main Power

- 1** Make sure that the power cord is firmly plugged into the wall outlet.
- 2** Turn on the main power switch.



ZEBH320N

Starting the Machine

- 1 Press the operation switch to make the On indicator go on.

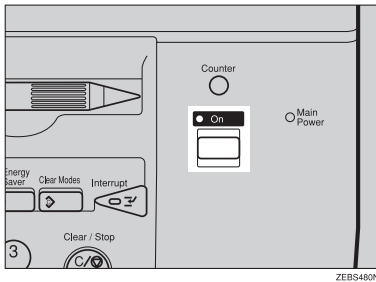

Note

- If the power is not turned on when the operation switch is pressed, check if the main power switch is on. If off, turn it on.
- During the warm-up period (about 8.5 minutes), you can use the Auto Start function. ⇒ P.54 "Auto Start".

When the machine is set for user codes

- 1 Enter your user code with the number keys. Then press the [#] key.

Note

- To prevent others from making copies with your user code, press the **[Clear Modes]** key and the **[Clear / Stop]** key simultaneously after copying.

Reference

For details about how to set user codes, ⇒ P.217 "General Features".

When the Energy Saver indicator is lit

The machine is in Energy Saver mode.

- 1 Press any key.

The machine will return to the ready condition.

Note

- The machine will also return to the ready condition when an original is set in the document feeder, or when the platen cover or the document feeder is opened.

Shutting down the machine

- 1** Press the operation switch to make the On indicator go off.

Turning off the main power

- 1** Turn off the main power switch.
The main power indicator of the operation panel goes off.

Originals

Standard Size Originals

The machine will detect the following sizes and directions as standard size originals:

◆ When you place originals on the exposure glass

Metric version	A3☐, B4☐, A4☐☐, B5☐☐, 8 ¹ / ₂ "×13"☐
Inch version	11"×17"☐, 10"×14"☐, 8 ¹ / ₂ "×13"☐, 8 ¹ / ₂ "×11"☐☐

◆ When you load originals in the document feeder

Metric version	A3☐, B4☐, A4☐☐, B5☐☐, A5☐☐, B6☐☐, 8 ¹ / ₂ "×13"☐, 8 ¹ / ₂ "×11"☐, 11"×17"☐, 11"×8 ¹ / ₂ "☐
Inch version	11"×17"☐, 8 ¹ / ₂ "×14"☐, 8 ¹ / ₂ "×11"☐☐, 5 ¹ / ₂ "×8 ¹ / ₂ "☐☐, 11"×15"☐, A4☐☐, 10"×14"☐, 8"×13"☐, 8"×10"☐





Recommended Originals

🔍 Reference

For information about what originals the document feeder can handle, ⇒ P.239 "Document Feeder (Option)".

Non-recommended Originals for the Document Feeder

Note

- The following types of originals are not recommended for use with the document feeder. Place them directly on the exposure glass.
- Originals thicker than 128g/m², 34 lb
- Originals thinner than 40g/m², 11 lb
- For originals between 40 and 52g/m², 11 and 14 lb, the document feeder must be set to ADF Thin paper mode with the user tools.
- Originals larger than A3, 11" × 17"
- Originals smaller than B6  , 5¹/₂" × 8¹/₂"  
- Folded, curled, creased, or damaged originals
- Mailing labels, or perforated originals
- Bound, stapled, or clipped originals
- OHP transparencies
- Translucent paper
- Pasted originals
- Damp originals
- Sticky originals
- Wavy originals
- Originals that are not made from paper
- Originals written in pencil on both sides, or two-sided carbon originals
- Thermal fax paper, CRO (camera ready originals) or aluminum foil
- Books, pamphlets, and booklets

Placing Originals on the Exposure Glass

- 1** Lift the platen cover or the document feeder.
- 2** Place the original face down on the exposure glass. The original should be aligned to the rear left corner.

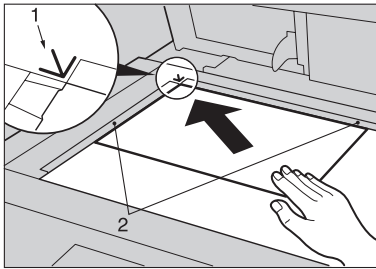

TRSR010E

- 1.** Reference mark
- 2.** Scale

 **Note**

- Start with the first page to be copied.

- 3** Lower the platen cover or the document feeder.

Loading a Stack of Originals in the Document Feeder

You can insert a stack of originals into the document feeder. These originals are individually fed onto and removed from the exposure glass.

Note

- Some originals are unsuitable for the document feeder. ⇒ P.17 “*Non-recommended Originals for the Document Feeder*”.
- Do not press down or hold originals after inserting them.
- While originals are fed from the original table to the exposure glass, do not pull them out.
- Do not lift the document feeder until the original has been completely fed out.

1 Correct any curl, fold, or crease in the originals before loading them.

2 Make sure the Insert Original indicator is lit and the exposure glass is clear of originals.

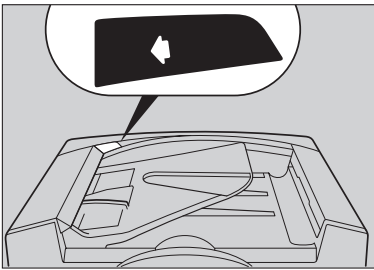

TRSR050E

3 Adjust the guide to the original size.

- 4 Load the originals **face up** into the document feeder until the Insert Original indicator goes off.

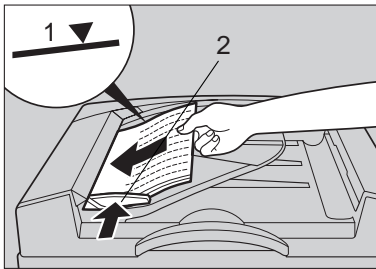

1. Limit mark

2. Original guide

Note

- The last page should be on the bottom.
- The original guide must touch the front side of the originals.
- Do not stack originals above the limit mark.

Loading one Original at a Time in the Document Feeder

If you set one original at a time in the document feeder, the second and subsequent originals can be fed and copied automatically without pressing the **[Start]** key.

Note

- Do not press down or hold originals after inserting them.
- While originals are fed from the original table to the exposure glass, do not pull them out.
- Do not lift the document feeder until the original has been completely fed out.

1 Correct any curl, fold, or crease in the originals before loading them.

2 Make sure the Insert Original indicator is lit and the exposure glass is clear of originals.

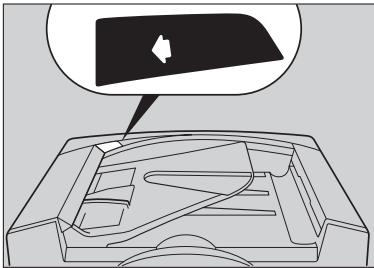

3 Adjust the guide to the original size.

4 Load the original face up into the document feeder until the Insert Original indicator goes off.

Note

- If you are copying a stack of originals one sheet at a time and you want to keep them in order, start with the last page of the originals.
- The original guide must touch the front side of the original.

5 Press the **[Start]** key.

- 6** While the Auto Feed indicator is lit after an original is fed, load the next original. The original is automatically fed and copied.



TCAR/070E

 **Note**

- You can adjust the time the machine waits before being ready for the next original with the user tools.

Loading Originals of Different Sizes in the Document Feeder

Preparation

To use this function, you have to select ADF Mixed Sizes mode with the user tools. ⇒ P.223 “Duplex/ADF/Sorter”.

You can insert a stack of originals of different standard sizes (e.g. A4, B5 etc.) into the document feeder. These originals are individually fed onto and removed from the exposure glass.

Limitation

- The weight of originals that can be set with this function is 52 - 81g/m², 14 - 20 lb.
- Smaller size originals might be skewed a little.

Note

- If your stack of originals contains pages of different sizes, make sure that:
 - Longer originals are at the bottom of the stack, and shorter originals are at the top.
 - All originals are flush with the back fence of the document feeder.

1 Align the rear and left edges of the originals as shown in the illustration.

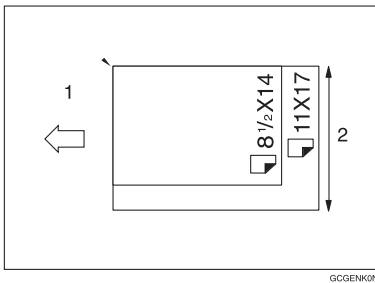

1. Document feeder feed direction

2. Vertical size

2 Adjust the guide to the widest original size.

3 Load the aligned originals face up into the document feeder.

Placing Custom Sized Originals

When copying from custom sized originals, enter the original size so that the copy is well aligned.

⚠ Limitation

- You must place your custom size originals on the exposure glass.

🔍 Reference

For details about the standard sizes the machine can detect, ⇒ P.16 “Standard Size Originals”.

📝 Note

- The dimensions you can enter must be within the following ranges:

Vertical size	50 - 297mm (in 1mm steps), 2.0" - 11.7" (in 0.1" steps)
Horizontal size	50 - 432mm (in 1mm steps), 2.0" - 17" (in 0.1" steps)

1 Select the copy paper size.

2 Press the [Custom Size Orig.] key.

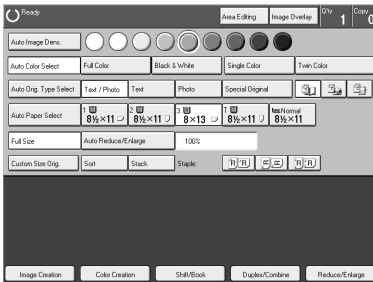

3 Make sure that the [Orig. Horiz.] key is selected. Enter the horizontal size with the number keys, and then press the [#] key.

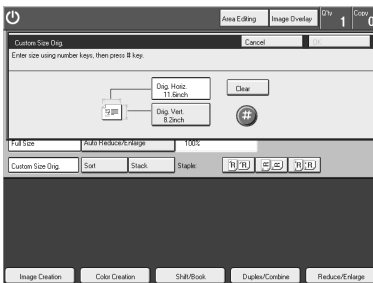

📝 Note

- To change the value entered, press the [Clear] key, and then enter a new value.

- 4** Press the **[Orig. Vert.]** key and enter the vertical size with the number keys, and then press the **[#]** key.
- 5** Press the **[OK]** key.
- 6** Place your original on the exposure glass, and then press the **[Start]** key.

Removing the Platen Cover to Copy a Large Original

1

You can remove the platen cover to copy a large (more than A3, 11" × 17") original.

Note

□ You cannot remove the document feeder.

To remove the platen cover, lift it out.

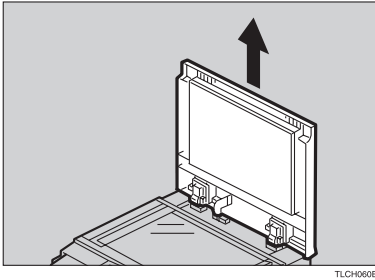

Note

□ Lift the platen cover with both hands. Place the removed cover on a flat surface where it will not be damaged.

To reset the platen cover, align the pins of the platen cover and the holes of the copier. Then push the platen cover onto the copier.

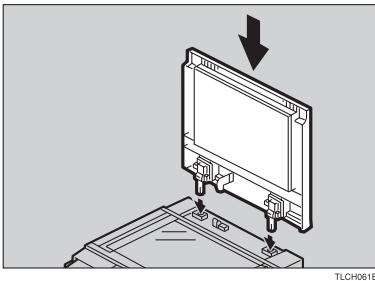

2. Copying

Basic Procedure

- 1 Place your original on the exposure glass or in the document feeder.
- 2 Make sure that the [Auto Color Select], [Text / Photo], [Auto Paper Select], [Full Size] keys are selected.

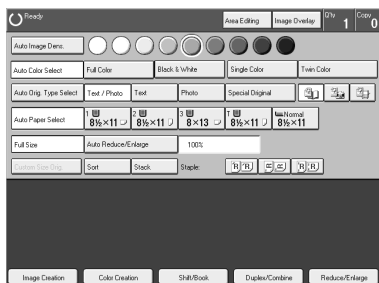

Note

- ❑ Auto Color Select ⇒ P.30 "Auto color select mode".
- ❑ Text/Photo ⇒ P.36 "Text/Photo mode".
- ❑ Auto Paper Select ⇒ P.39 "Auto paper select".

- 3 Enter the number of copies required with the number keys.

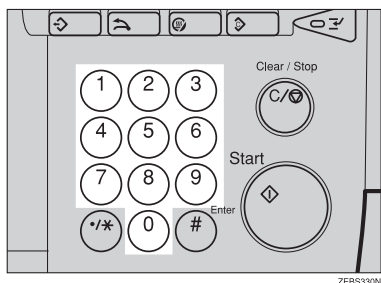

Note

- ❑ To change the number entered, press the [Clear/Stop] key, and then enter the new number.

4 Press the **[Start]** key.

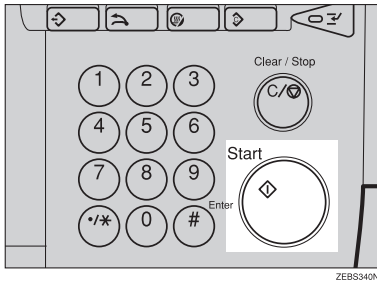

Note

- To stop the machine during a multi-copy run, press the **[Clear/Stop]** key.
- If you want to change the settings, press the **[Yes]** key. If you want to resume the copy run, press the **[Resume]** key.
- To return the machine to the initial condition after copying, press the **[Clear Modes]** key.

Adjusting Copy Image Density

Image density affects the contrast of copies. With these functions you can control the image density so that copies match originals. Make the selection you require, and then place your originals and press the **[Start]** key.

Auto image density

The machine automatically controls the image density.

Note

- Auto Image Density and Auto Color Select cannot be set together.

1 If Auto Color Select mode is selected, select another color mode to cancel it.
 ⇒ P.30 "Selecting a Color Mode".

2 Press the **[Auto Image Density]** key.

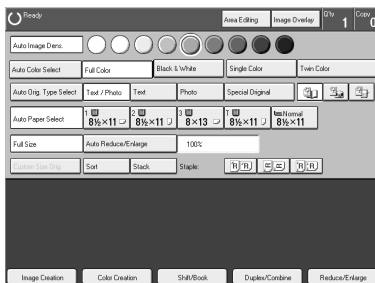

Manual image density

If you require darker or lighter copies, adjust the image density yourself.

- 1** If the [Auto Image Density] key is selected, press it to cancel it.
- 2** Press the desired color density level.

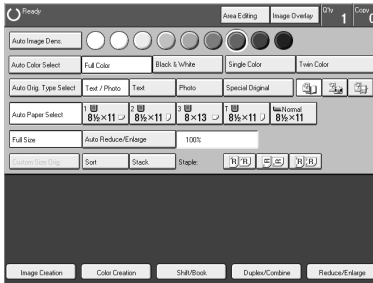

Combined auto and manual image density

Use when copying originals with a dirty background (such as newspapers). You can adjust the foreground density while masking out the dark background.

- 1** If Auto Color Select mode is selected, select another color mode to cancel it.
⇒ P.30 "Selecting a Color Mode".
- 2** Press the [Auto Image Density] key.

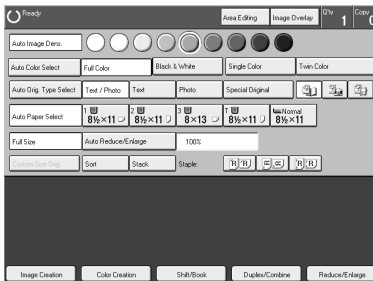

- 3** Press the desired color density level.

Selecting a Color Mode

Select a color mode that best suits your originals and copying requirements.

Auto color select mode

The machine automatically detects whether the original has color parts or not. Originals with only black images will be copied in Black & White mode. Originals with some color areas will be copied in Full Color mode.

Note

- If your original contains only black and white, use Black & White mode. Using Auto Color Select mode will take you a long time to complete the job.

1 Make sure that the [Auto Color Select] key is selected.

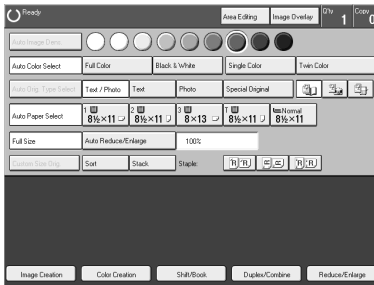

2 Place your originals, and then press the [Start] key.

Full color copy mode

This function makes copies in full color.

Note

- You can adjust the overall color tone of copies. ⇒ P.131 “Color Balance”.

1 Press the [Full Color] key.

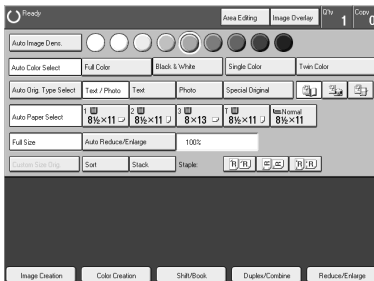

Black & White copy mode

This function makes copies in black.

1 Press the [Black & White] key.

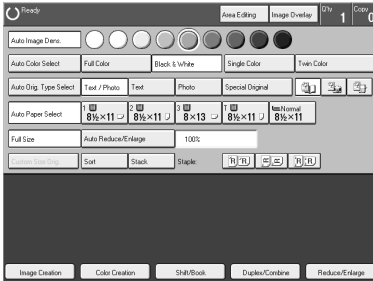

2 Place your originals, and then press the [Start] key.

Single color mode

This function makes copies in single colors.

Note

- 12 basic colors: Yellow, Orange, Red, Magenta, Green, Cyan, Blue, Yellow Green, Beige, Marine Blue, Pink, Purple
- 15 user colors: Up to 15 colors can be manually mixed and stored in memory. ⇒ P.147 "Mixing Colors Manually with the Number Keys".
- 1 scanned color (option): You can scan in a color from an original. ⇒ P.33 "Scanned color".

Basic color

1 Press the [Single Color] key.

2 Select the color.

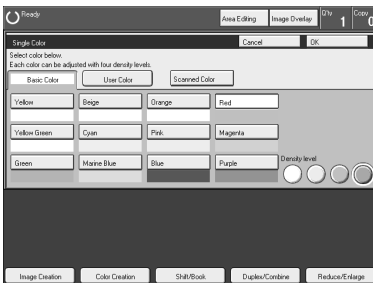

Note

- You can select the color density level.

3 Press the [OK] key.

4 Place your originals, and then press the [Start] key.

User colors

Note

When Single Color copying, user colors might come out lighter.

1 Press the [Single Color] key.

2 Press the [User Color] key.

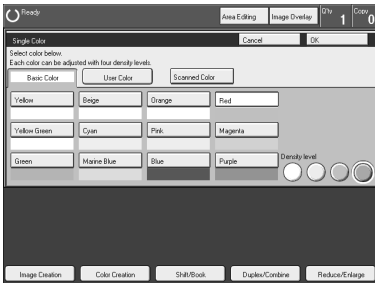

3 Select the color.

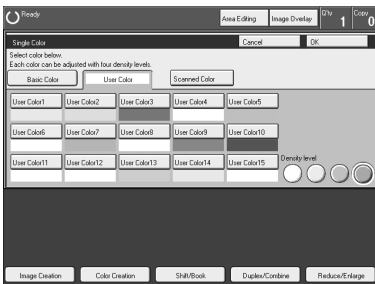

Note

You can select the color density level.

4 Press the [OK] key.

5 Place your originals, and then press the [Start] key.

Scanned color

The optional editing kit is required to use this function.

Note

- “Scanned color” means that the color is specified from the original image directly.
- When Single Color copying, Scanned colors might come out lighter.

1 Press the [Single Color] key.

2 Place your original, and then press the [Scanned Color] key.

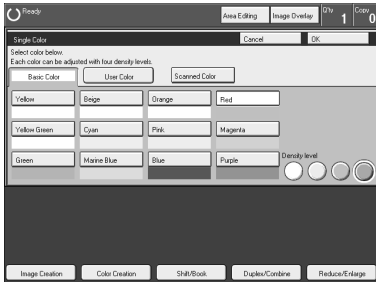

Note

- The image of the original is displayed.

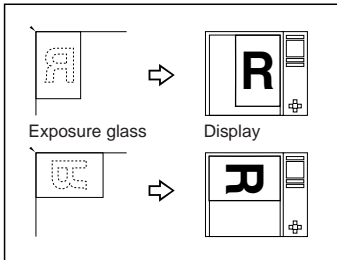

GCAREASE

3 Press the color on the image you wish to scan in with the editor pen.

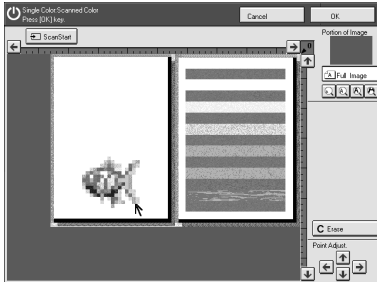

Note

- Point to an area of color with a radius of at least 5 mm.
- To cancel the pointing, press the **[Erase]** key.
- For details about this display, ⇒ P.154 “Designate Area Display”.

4 Press the **[OK]** key.

Note

- The color you have chosen is scanned in.

5 Press the **[Start]** key.

Twin Color Mode

Two methods are available:

◆ **Color Copy**

Reproduces black areas of the original in one selected color and areas in other colors using the second selected color.

Note

- You can have colored areas copied in one of the following colors: Red, Green, Blue, Yellow, Cyan, Magenta, Yellow Green, Orange, Marine Blue, Beige, Pink, Purple and User Colors
- You can have black parts copied in one of the following colors: Red, Green, Blue, Yellow, Cyan, Magenta, Yellow Green, Orange, Marine Blue, Beige, Pink, Purple and User Colors

◆ **Red & Black**

Reproduces red areas of the original in red, and areas in other colors using black.

Note

- You cannot change the color.

Twin Color (Color Copy)

- 1 Press the [Twin Color] key.
- 2 Select the color you want to copy the color parts of the original in.

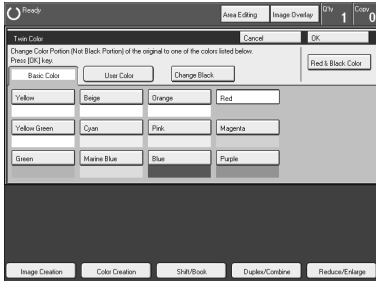

- 3 If you wish to copy black parts using a different color, press the [Change Black] key.

Note

- If you do not want to do this, go to step 5.

- 4 Select the color you want to copy the black parts of the original in. Then press the [OK] key.
- 5 Press the [OK] key.
- 6 Place your originals, and then press the [Start] key.

Twin Color (Red & Black Copy)

Note

- If Color Sensitivity is set to wide, the machine recognizes orange or purple as red. This adjustment affects Color Erase or Color Conversion. ⇒ P.142 "Image Adjustment".

- 1 Press the [Twin Color] key.
- 2 Press the [Red & Black Color] key, and then press the [OK] key.



2

3 Place your originals, and then press the **[Start]** key.

Selecting the Original Image Type

To optimize the likeness between copies and originals, select an image type that matches your originals.

Note

- You can adjust the readability of black lettering in colored areas, ⇒ P.140 “Color Adjustment”.

Auto original type select mode

This mode is selected automatically when Full Color mode is selected and optimizes the likeness of copies to originals.

1 Press the **[Auto Orig. Type Select]** key.

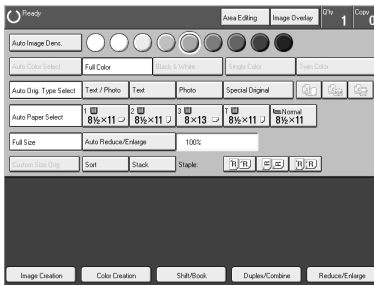



2 Place your originals, and then press the **[Start]** key.

Text/Photo mode

This mode automatically detects the areas of your original containing text or photographs. The text areas are copied using Text mode, and the photographs are copied with Photo mode.

Note

- There are 3 types of Photo mode:
 -  **[Press Print]:**
Use when copying photographs or pictures that are printed on paper (e.g. magazines).
 -  **[Glossy Photo]:**
Use when copying developed photographs.
 -  **[2nd Generation]:**
Use when copying copies or originals generated by printers.

- 1 Make sure that the [Text / Photo] key is selected.

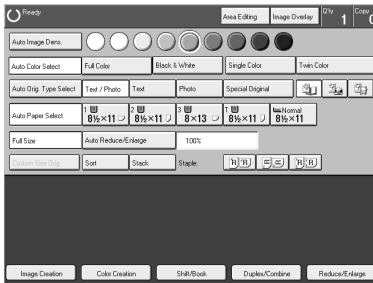

Note

- If not, press the [Text / Photo] key.

- 2 Select the photo mode.
- 3 Place your originals, and then press the [Start] key.

Text mode

This modes is suitable for copying originals consisting of characters, line diagrams, and letters, but not photographic images.

- 1 Press the [Text] key.

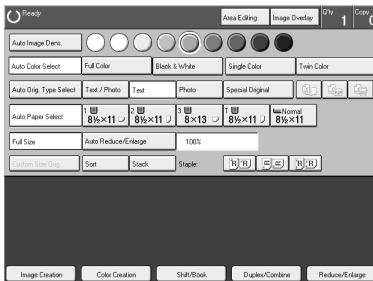



- 2 Place your originals, and then press the [Start] key.

Photo mode

This mode is suitable for copying originals consisting of pictures, photographs, and screened letters/areas, but not solid letters.

Note

□ There are 3 types of Photo mode:

-  **[Press Print]:**
Use when copying photographs or pictures that are printed on paper (e.g. magazines).
-  **[Glossy Photo]:**
Use when copying developed photographs.
-  **[2nd Generation]:**
Use when copying copies or originals generated by printers.

1 Press the [Photo] key.

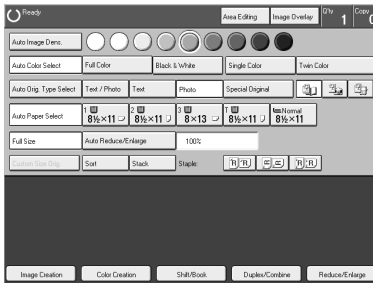

2 Select the photo mode.

3 Place your originals, and then press the [Start] key.

Special original mode

Use this function for originals written in highlight pen, originals printed from inkjet printers, or maps.

1 Press the [Special Original] key.

2 Select the original type from the [Highlight Pen], [Inkjet Output], and [Map] key.

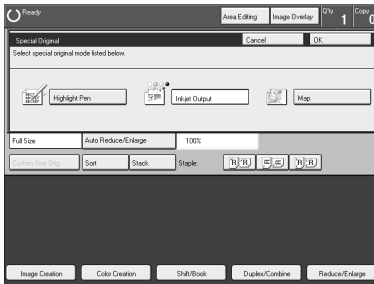

3 Place your originals, and then press the [Start] key.

Selecting the Copy Paper Size

Select a suitable size of copy paper based on the original size and the reproduction ratio.

Auto paper select

The machine automatically selects a suitable size of copy paper based on the original size and the reproduction ratio.

Reference

Regarding functions that cannot be used together with this function, ⇒ P.121 “Combination Chart”.

Note

- Sizes of certain originals might not be detected depending on the original's size and type. In this case, select the size manually.
- You can set thick or extra thick copy paper in tray 2 and 3. After setting it, specify the weight of the paper. For details about how to specify the weight of the paper, see “Tray Paper Type” ⇒ P.213 “System settings”.

1 Make sure that the [Auto Paper Select] key is selected.

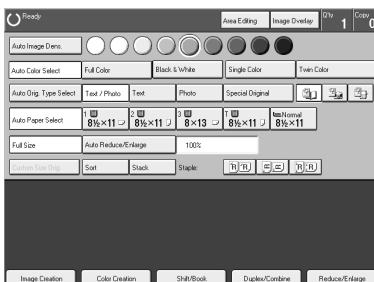

Manual paper select

You can select the copy paper manually.

1 Select the copy paper.

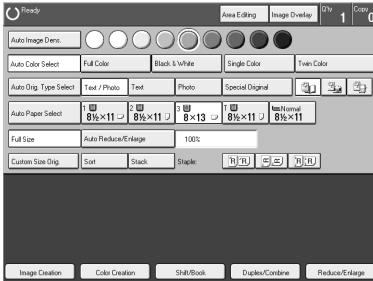



Image Rotation

If the direction in which your original is set (landscape or portrait) is different from the paper you are copying onto, this function rotates the original image by 90° and fits it on the copy paper. This function works when Auto Paper Select or Auto Reduce/Enlarge are selected. ⇒ P.217 “General Features”

Note

□ Image Rotation does not work with the following functions:

- Area Editing
- Series Copies (Book → 1-sided)
- Duplex Copies (Book → 2-sided, Multi → 2-sided)
- Image Creation (Repeat Image, Outline Image, Shadow Image)
- Poster Mode
- Enlargements from A4, 8¹/₂"×11"  to A3, 11"×17" 

Copying from the Bypass Tray

Use the bypass tray to copy onto thick paper, adhesive labels, OHP transparencies, or custom size paper. Also use the bypass tray to copy onto the reverse side of paper that has already been copied onto.

Note

The following limitations apply:

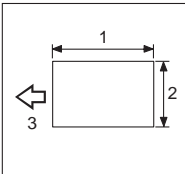
Acceptable paper types	Normal paper (64 - 105g/m ² , 17 - 28 lb) Thick paper (105 - 157g/m ² , 28 - 42 lb) Extra thick paper (157 - 256g/m ² , 42 - 68 lb) Post cards OHP transparencies Adhesive labels Translucent paper	
	Standard size	Metric version: <input type="checkbox"/> : A3, B4, A4, B5, A5, B6, A6, 11" × 17", 12" × 18", 13" × 19" <input type="checkbox"/> : A4, B5, A5, 11" × 8 ¹ / ₂ "
		Inch version: <input type="checkbox"/> : 8 ¹ / ₂ " × 11", 8 ¹ / ₂ " × 5 ¹ / ₂ ", 10" × 14", 11" × 17", 12" × 18", 13" × 19", A3 <input type="checkbox"/> : 8 ¹ / ₂ " × 11", 8 ¹ / ₂ " × 5 ¹ / ₂ ", A4
	Custom size	Metric version: Vertical: 100 - 330mm (in 1mm steps) Horizontal: 140 - 483mm (in 1mm steps)
	 1: Horizontal 2: Vertical 3: Feed direction	Inch version: Vertical: 3.9" - 13" (in 0.1" steps) Horizontal: 5.5" - 19" (in 0.1" steps)
Number of sheets that can be set at one time	Normal paper: 250 sheets Extra thick paper, Post cards: 100 sheets Thick paper: 150 sheets Adhesive labels: 1 sheet Translucent paper ^{*1} , OHP transparencies: 200 sheets	

^{*1} After copying, return the paper to its package.

- Select one of the following settings or keys:
- **[Normal]**: normal paper, adhesive labels
 - **[Thick]**: thick paper, post cards, translucent paper
 - **[Extra Thick]**: Heavier than 157g/m², 42 lb
 - **[OHP]**: OHP transparencies
 - **[Duplex Back]**: Copying onto the reverse side of paper that has been already copied onto. ⇒ P.49 “Copying onto the reverse side of paper”.
 - **[Custom Size]**: Custom sized paper. ⇒ P.45 “Copying onto custom size paper with the bypass tray”.
- When you copy onto OHP transparencies, you can select whether a blank slip sheet is inserted between OHP transparencies.

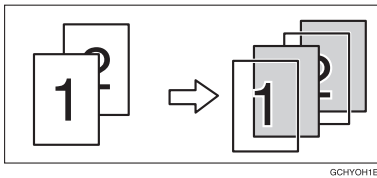

- When you set several sheets at a time, fan them to get air between them before loading.
- If the copy paper is curled, gently roll it to remove the curl.
- When you copy onto OHP transparencies, insert them with the copy side up.
- Do not stack copy paper above the limit mark.
- If the copy paper is bent, correct it before setting paper in the bypass tray. If the bent part is not corrected, a paper misfeed might occur.
- When the optional sorter stapler is installed, copies made onto thick or OHP transparencies are not delivered in the proof tray but in the first bin instead.
- When setting custom size paper, be sure to set the size after pressing the **[Custom Size]** key.

Important

- Do not set normal paper in the Extra Thick mode, otherwise a paper misfeed or other malfunction might occur.

Copying onto standard size paper with the bypass tray

Note

- When you copy onto the reverse side of paper that has been already copied onto, ⇒ P.49 "Copying onto the reverse side of paper".

1 Open the bypass tray.

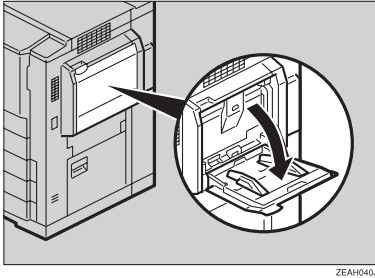

ZEAH040J

2 Press the [Normal], [Thick], [Extra Thick], or [OHP] key.

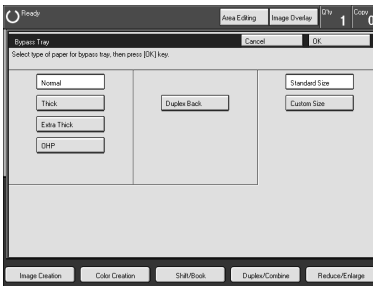

Note

- Make sure that the **[Standard Size]** key is selected.
- When you copy onto OHP transparencies, you can select whether a blank slip sheet is inserted between OHP transparencies.

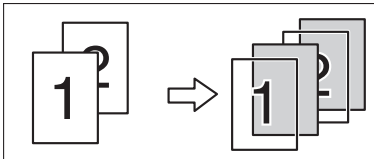

GCHYQH1E

3 Press the [OK] key.

2

4 Adjust the paper guides to the paper size.

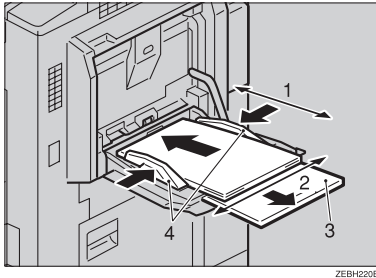

1. Horizontal size

3. Extender

2. Vertical size

4. Paper guides

Note

- Make sure the paper size and direction in the bypass tray is displayed on the operation panel.
- Make sure that the paper guides match the paper size. If the paper guides are not adjusted to the paper size properly, paper might be skewed or a paper misfeed might occur.
- With large copy paper (more than A4, 8¹/₂" × 11"), swing out the extender.

5 Insert the paper into the bypass tray until it stops. The side you wish to copy onto should be face up.

6 Place your originals, and then press the **[Start]** key.

Note

- The copy paper rises, and then copying starts. Shortly after copying finishes, the copy paper descends.

Copying onto custom size paper with the bypass tray

Preparation

You can register custom paper sizes you use often in keys **[Custom1]**, **[Custom2]**, and **[Custom3]** with the user tools. ⇒ P.213 “System settings”.

Note

- Be sure to set the paper size or a paper misfeed might occur.

1 Open the bypass tray.

2 Press the **[Normal]**, **[Thick]**, **[Extra Thick]**, or **[OHP]** key.

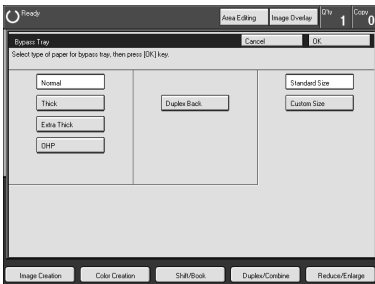

3 Press the **[Custom Size]** key.

4 Select **[Custom1]**, **[Custom2]**, **[Custom3]** or **[Enter Size]** keys.

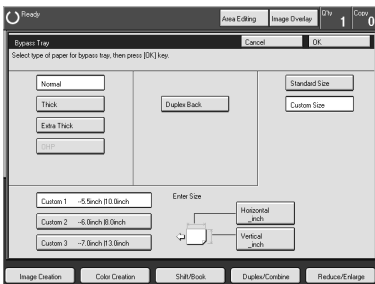

Note

- If you select **[Custom1]**, **[Custom2]** or **[Custom3]**, go to step **7**.

2

- 5** If you select **[Enter Size]** in step **4**, enter the horizontal paper size with the number keys, and then press the **[#]** key.

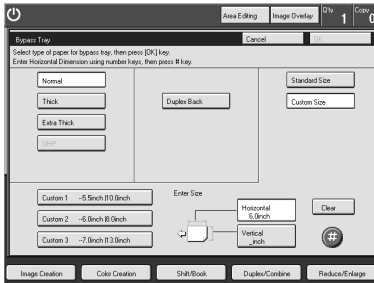

Note

- To change the value entered, press the **[Clear]** key and enter a new value.

- 6** Enter the vertical paper size with the number keys, and then press the **[#]** key.

- 7** Press the **[OK]** key.

- 8** Adjust the paper guides to the paper size.

Note

- Make sure that the paper guides match the paper size. If the paper guides are not adjusted to the paper size properly, paper might be skewed or a paper misfeed might occur.

- 9** Insert the paper into the bypass tray.

- 10** Place your originals, and then press the **[Start]** key.

Making A3, 11" × 17" full bleed copies

By sliding the paper guides of the bypass tray to a size greater than A3 (11"), A3 11" × 17" full bleed copying mode is automatically selected.

In this mode, you can make A3, 11" × 17" full bleed copies with 12" × 18" or 13" × 19" paper. This is useful for making A3, 11" × 17" size copies with a colored background (e.g. catalogues).

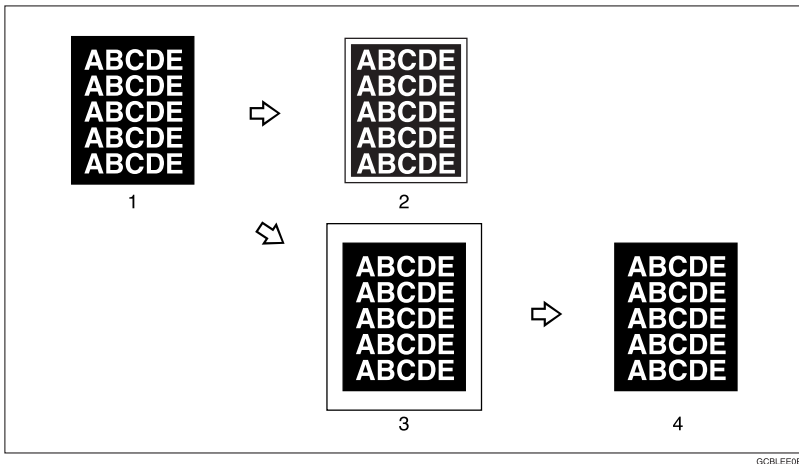

GCBLEE0E

1. A3, 11" × 17" size Original
2. In standard copy mode, margins appear on copies

3. 12" × 18" or 13" × 19" Full Bleed Copy

4. Cut around the margins to produce a full image

Note

- This function can be used with 12" × 18" or 13" × 19" paper.
- When A3, 11" × 17" full bleed copying mode is selected, the paper direction is automatically changed to widthwise .
- When A3, 11" × 17" full bleed copying is made, the original image is copied onto the center.

- By sliding the paper guides of the bypass tray, the machine enters A3, 11" × 17" full bleed copying mode automatically.

◆ Left guide

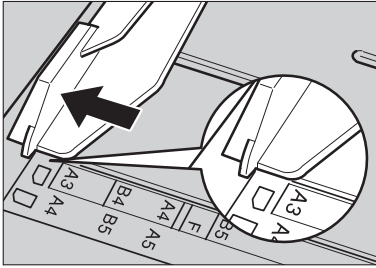

TCAY080E

◆ Right guide

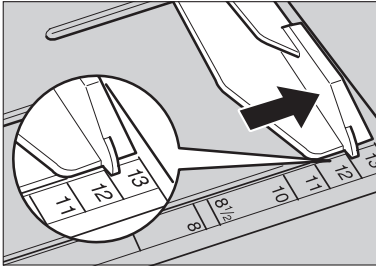

TCAY070E











2

Copying onto the reverse side of paper

You can copy onto the reverse side of paper that has been already copied onto.

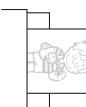
Note

- If you wish to copy on both sides of the paper, use the Duplex feature. ⇒ P.69 "Duplex".
- Make sure that you place your original and the copy paper in the correct direction to achieve the results required.

Original set on the exposure glass	Copy paper set in the bypass tray	Copies
		
GCMR280E		
		
GCMR290E		
		
GCMR300E		
		
GCMR310E		

- If Duplex copying cannot be done because of paper problems, place paper on the bypass tray to copy on the front side, and once again copy on the backside.

- You cannot use this function for OHP transparencies, translucent paper, adhesive labels and postcards.
- Do not use copy paper that has been already copied onto by other machines.
- If the copy paper is bent, correct it before placing paper in the bypass tray. If the bent is not corrected, a paper misfeed might occur.

1 Open the bypass tray.

2 Insert the paper into the bypass tray.

 **Note**

- Make sure the front side (the side that has been copied onto) faces down.
- Make sure that you place your original and the copy paper in the correct direction to achieve the results required. ⇒ P.49 “Copying onto the reverse side of paper”.

3 Press the [Normal], [Thick] or [Extra Thick] key.

4 Press the [Duplex Back] key.

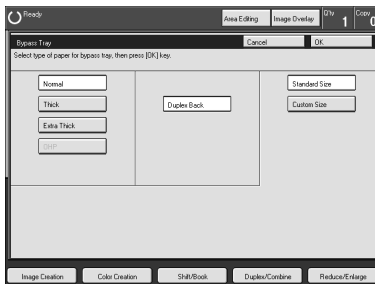

 **Note**

- To copy onto custom size paper, press the [Custom Size] key and select or enter the size. For details, ⇒ P.45 “Copying onto custom size paper with the bypass tray”.

5 Press the [OK] key.

6 Adjust the paper guides to the paper size.

 **Note**

- Make sure that the paper guides match the paper size. If the paper guides are not adjusted to the paper size properly, paper might be skewed or a paper misfeed might occur.

7 Place your originals, and then press the [Start] key.

Auto Reduce/Enlarge



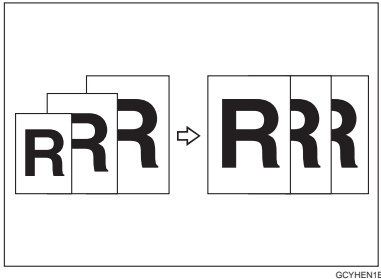

The machine can select the proper reproduction ratio based on the selected paper size and the original size.



Reference

Regarding other functions that cannot be used together with this function, ⇒ P.121 "Combination Chart".



Example:

- Metric version: original: A3 , copy paper: A4 
- Inch version: original: 11" × 17" , copy paper: 8¹/₂" × 11" 

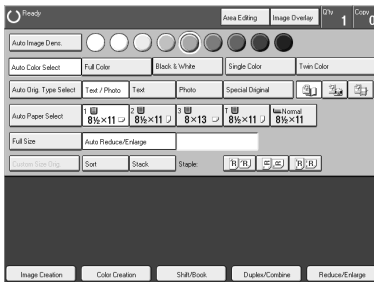
1 Press the [Auto Reduce/Enlarge] key.



2 Place your original on the exposure glass or in the document feeder.

3 Choose your copy paper size (e.g. A4 , 8¹/₂" × 11" ).

4 Press the [Start] key. The original image is enlarged or reduced to fit the selected copy paper.

Energy Saver Mode

If you do not operate the machine for a certain period after copying or press the **[Energy Saver]** key, the display goes out and the machine enters Energy Saver mode. When you press the **[Energy Saver]** key again, when the originals are loaded in the document feeder or when the platen cover or document feeder is opened, the machine returns to the ready condition. In Energy Saver mode, the machine uses less electricity.

1 Press the **[Energy Saver]** key to enter the Energy Saver mode.

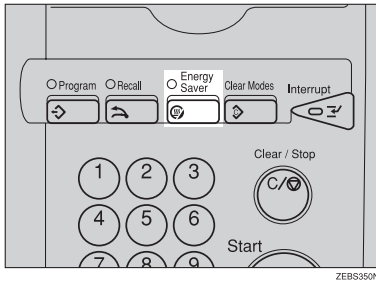

Note

- To exit this mode, press the **[Energy Saver]** key again.

Auto Off Mode

This machine automatically turns itself off 90 minutes after the last copy or print job has finished. If you wish to make copies when the machine is in Auto Off mode, press the operation switch.

Reference

For details about how to change the default interval, see “Auto Timer” on ⇒ P.213 “System settings”.

Interrupt Copying

Use the **[Interrupt]** key to interrupt a copy run and make urgently needed copies.

Reference

Regarding other functions that cannot be used together with this function, ⇒ P.121 “Combination Chart”.

- 1 Press the **[Interrupt]** key. The machine will stop the copy run and store the present settings in memory before returning to ready condition.

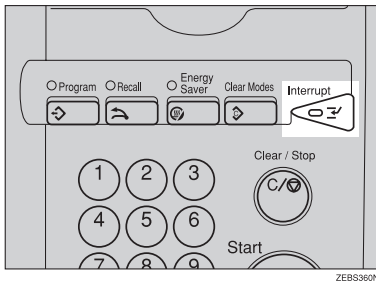

- 2 Remove the previous originals. Place your original on the exposure glass or in the document feeder for interrupt copying.
- 3 Make your copies.
- 4 After interrupt copying is completed, press the **[Interrupt]** key again. The machine will recall the previous copy settings.
- 5 Replace the previous originals and press the **[Start]** key to resume the previous run.

2

Auto Start

If you press the **[Start]** key during the warm-up period, the **[Start]** key will blink and the machine will start copying after the warm-up period.

1 Set your copy settings during the warm-up period.

2 Press the **[Start]** key.

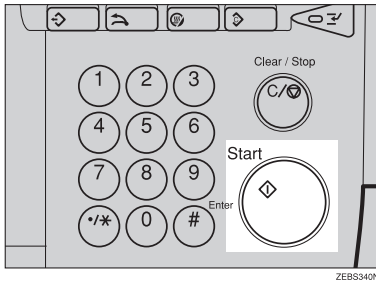

Note

- To cancel Auto Start, press the **[Clear/Stop]** key.

Recall

This machine automatically stores the previous job settings. If you want to copy with the same settings as the previous job, press the **[Recall]** key. You can also change the recalled job settings.

Note

- You cannot recall area editing and image overlay.

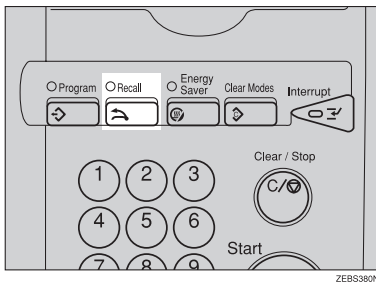

Program

You can store up to five frequently used copy job settings in machine memory and recall them for future use.

Note

- If you want to change a stored program, overwrite the program.

Storing your settings

- 1** Set the copy settings you want to put into memory.
- 2** Press the **[Program]** key.

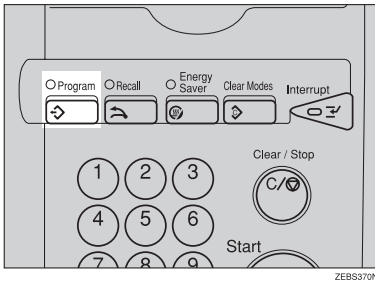

- 3** Press the **[Program]** key.



- 4** Select the program number you want to store the settings in.

Note

- If this program number is already being used, the machine asks whether you wish to overwrite it or not. Press the **[Yes]** or **[No]** key.

Recalling your settings

1 Press the **[Program]** key.

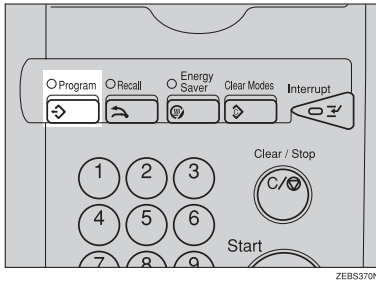

Note

- If you want to recall Area Edit settings stored in a program, press the **[Area Editing]** key, and then press the **[Program]** key.
- After you recall the Area Edit settings stored in a program, you can change them. However, you can not add or delete the Area/Group.

2 Press the **[Recall]** key.

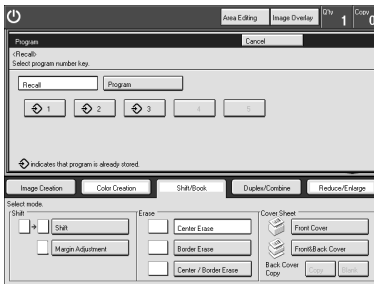

3 Select the program number you want to recall. The stored settings are displayed.

Note

- Only programs with  contain a program.

4 Place your originals, and then press the **[Start]** key.

Check Modes

By pressing the **[Check Modes]** key, you can see at a glance the modes you have selected.

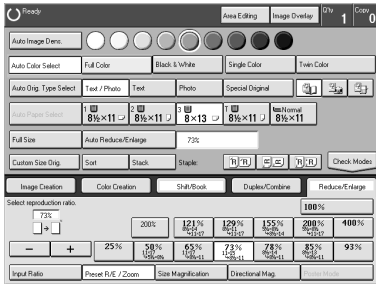

Counter

By pressing the **[Counter]** key, you can check the machine's counter.

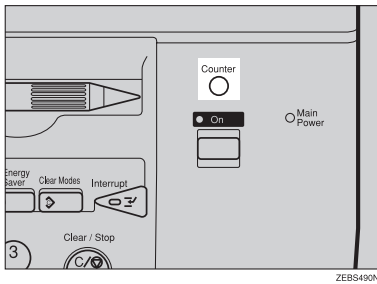

ZEB5490N

Reduce/Enlarge

Preset R/E

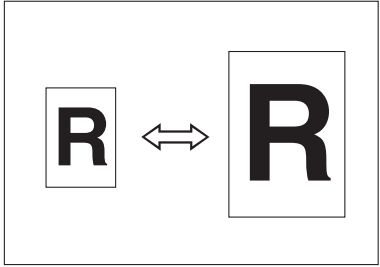

GCTHEN1E

Reference

Regarding other functions that cannot be used together with this function, ⇒ P.121 “Combination Chart”.

Note

- You can add up to two preset ratios with the user tools. ⇒ P.217 “General Features”.
- You can select a ratio regardless of the size of an original or copy paper. With some ratios, parts of the image might not be copied or margins will appear on copies.
- To return to 100%, press the [100%] key.

Reducing

1 Press the [Reduce/Enlarge] key.

2 Make sure that the [Preset R/E / Zoom] key is selected.

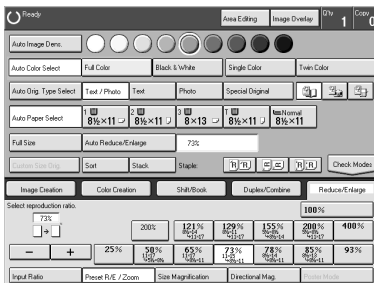

- 3** Select the ratio you require.
- 4** Place your originals, and then press the **[Start]** key.

Enlarging

- 1** Press the **[Reduce/Enlarge]** key.
- 2** Make sure that the **[Preset R/E / Zoom]** key is selected.

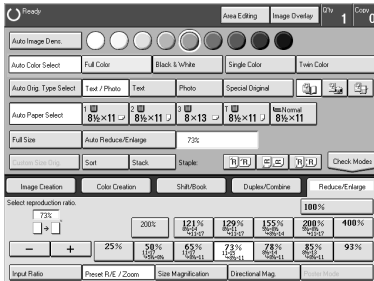

- 3** Select the ratio you require.

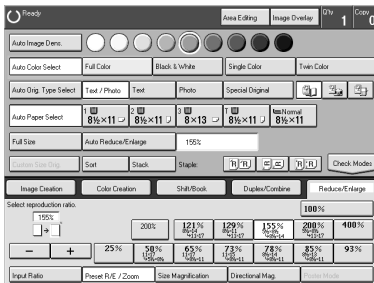

- 4** Place your originals, and then press the **[Start]** key.

Zoom



You can change the reproduction ratio from 25% to 400% in 1% steps.

Note

- You can select a ratio regardless of the size of an original or copy paper. With some ratios, parts of the image might not be copied or blank margins will appear on copies.
- To return to 100%, press the **[100%]** key.
- You can select a preset ratio which is near the desired ratio, and then press the **[Zoom]** key and adjust the ratio with the **[+]** or **[-]** key.
- There are two ways to set the ratios.

Using the [-] and [+] keys

- 1** Press the **[Reduce/Enlarge]** key.
- 2** Make sure that the **[Preset R/E / Zoom]** key is selected.

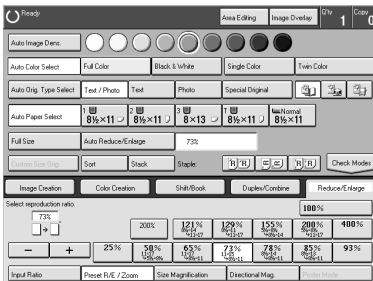

- 3** Adjust the reproduction ratio with the **[+]** or **[-]** key.
- 4** Place your originals, and then press the **[Start]** key.

Using the number keys

1 Press the [Reduce/Enlarge] key.

2 Press the [Input Ratio] keys.

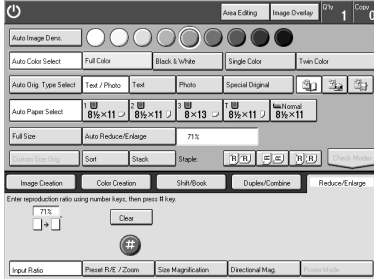

3 Enter the reproduction ratio with the number keys.

Note

□ To change the ratio entered, press the [Clear] key and enter a new ratio.

4 Press the [#] key.

5 Place your originals, and then press the [Start] key.

Size Magnification

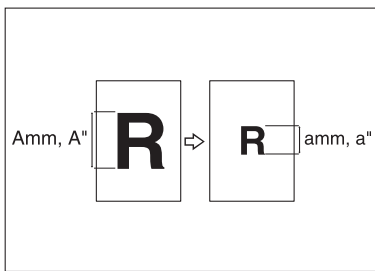

GCSIZE1E

The suitable reproduction ratio will be automatically selected when you enter the length of the original and the length of the copy image you want.

Note

□ You can select a ratio regardless of the size of an original or copy paper. With some ratio, parts of the image might not be copied or blank margins might appear on copies.

- You can select a ratio from between 25% to 400%.
- Up to 999mm (metric version), 99.99" (inch version) can be entered.

1 Press the **[Reduce/Enlarge]** key.

2 Press the **[Size Magnification]** key.

3 Enter the original size with the number keys, and then press the **[#]** key.

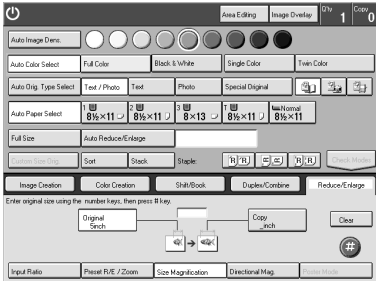

4 Enter the copy size with the number keys, and then press the **[#]** key.

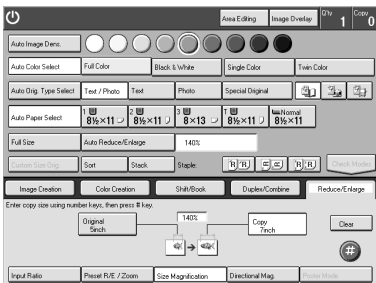

Note

- To change the ratio entered, press the **[Original]** key or the **[Copy]** key, and then enter a new ratio.

5 Place your originals, and then press the **[Start]** key.

Directional Magnification (%)

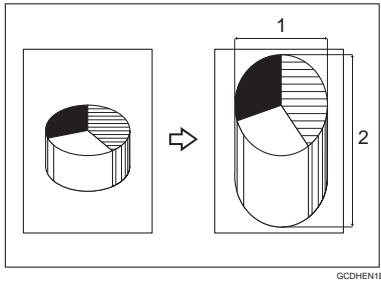

1. Horizontal %

2. Vertical %

Copies can be reduced or enlarged at different reproduction ratios horizontally and vertically.

Note

- You can select a ratio from between 25% to 400%.
- You can select a ratio regardless of the size of an original or copy paper. With some ratio, parts of the image might not be copied or blank margins might appear on copies.

1 Press the [Reduce/Enlarge] key.

2 Press the [Directional Mag.] key.

3 Make sure that the [Direct. Mag (%)] key is selected.

4 Enter the horizontal ratio with the number keys, and then press the [#] key.

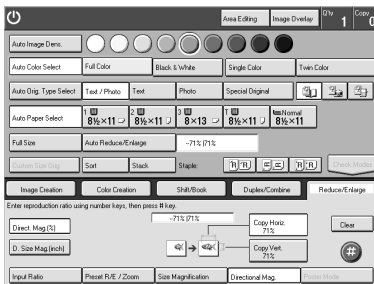

Note

- To change the ratio entered, press the [Clear] key and enter a new ratio.

5 Enter the vertical ratio with the number keys, and then press the [#] key.

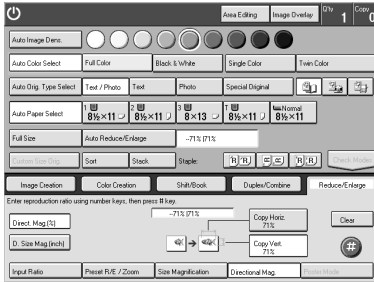

6 Place your originals, and then press the [Start] keys.

Directional Size Magnification (inch)

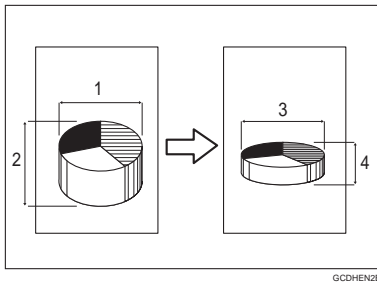

1. Horizontal original size

3. Horizontal copy size

2. Vertical original size

4. Vertical copy size

The suitable reproduction ratios will be automatically selected when you enter the horizontal and vertical lengths of the original and copy image you require.

Note

You can enter sizes within the following ranges:

Metric Version	1 - 999mm (in 1mm steps)
Inch Version	0.1" - 99.9" (in 0.1" steps)

If the calculated ratio is over the maximum or under the minimum ratio, it is corrected within the range of the ratio automatically. However, with some ratios, parts of the image might not be copied or blank margins might appear on copies.

- 1** Press the [Reduce/Enlarge] key.
- 2** Press the [Directional Mag.] key.
- 3** Press the [D. Size Mag. (inch)] key.
- 4** Enter the horizontal original size with the number keys, and then press the [#] key.

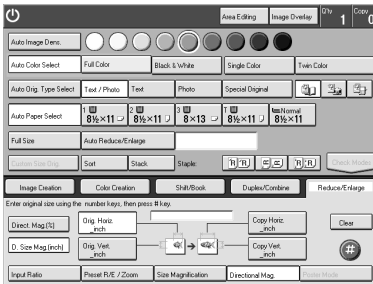

Note

- To change the value entered:
 - If you have not pressed the [#] key yet, press the [Clear] key and enter a new value.
 - If you have already pressed the [#] key, select the specified key and enter a value.

- 5** Enter the horizontal copy paper size with the number keys, and then press the [#] key.
- 6** Enter the vertical original size with the number keys, and then press the [#] key.

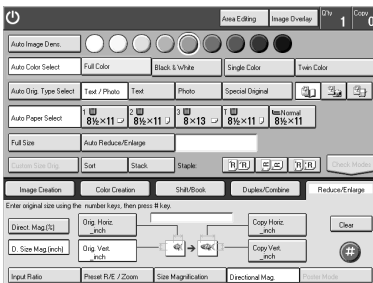

- 7** Enter the vertical copy paper size with the number keys, and then press the [#] key.
- 8** Place your originals, and then press the [Start] key.

Poster Mode

2

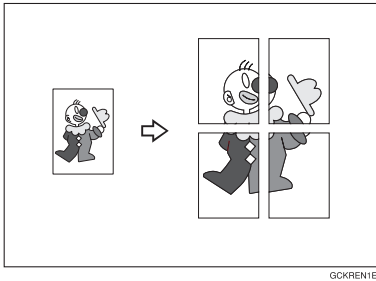

You can enlarge the complete image of originals onto several sheets. This function is convenient for making posters.

Note

- In this function, the copies are delivered with margins around the copy image (about 15mm, 0.6"). If you want to paste the sheets to make a poster (one large sheet), cut the margins out.

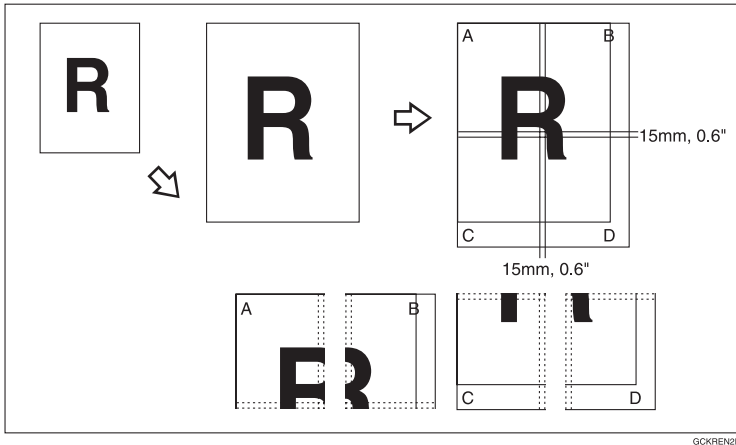

- You can specify different ratios or numbers of pages in the horizontal and vertical directions.

Limitation

- If the **[Auto Paper Select]** key is selected, you cannot use this function.
- You cannot use the document feeder for Poster Mode. Place your originals on the exposure glass.
- When you use the custom size originals for Poster Mode, blank pages will be fed out.

Using the [Number of Pages] key

By entering the desired number of pages, the machine automatically calculates the suitable enlargement ratio for copying.

- 1** Select the copy paper size.
- 2** Press the [Reduce/Enlarge] key.
- 3** Press the [Poster Mode] key.

Note

- If you are using Auto Color Select mode and then choose Poster Mode, the machine switches automatically to Full Color mode.

- 4** Make sure that the [Number of Pages] key is selected.
- 5** Enter the number of pages.

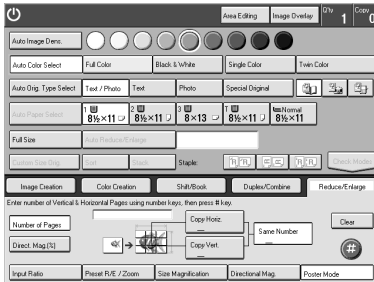

Note

- Up to 20 pages can be entered.
- You can specify different ratios or numbers of pages in the horizontal and vertical directions.
- If the number of pages coincides with an enlargement of more than 400%, blank pages will be fed out.

- 6** Press the [#] key.
- 7** Place your originals, and press the [Start] key.

Using the [Direct. Mag. (%) key

By entering the desired enlargement ratio, the machine automatically calculates the necessary number of copy pages.

- 1** Select the copy paper size.
- 2** Press the [Reduce/Enlarge] key.

- 3** Press the [Poster Mode] key.
- 4** Press the [Direct. Mag. (%)] key.
- 5** Enter the ratio.

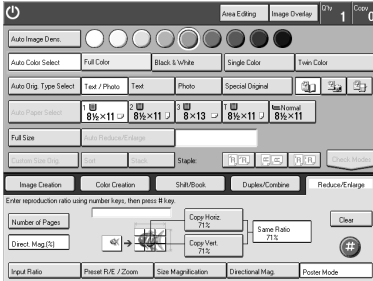

Note

- You can specify different ratios or numbers or pages in the horizontal and vertical directions.

- 6** Press the [#] key.
- 7** Place your originals, and then press the [Start] key.

Duplex

1 Sided → 2 Sided

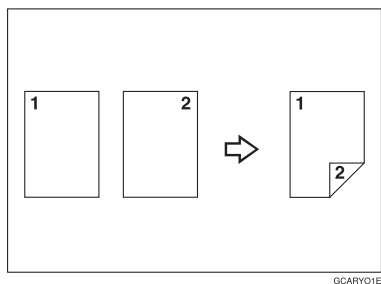

GCARYO1E

This function makes double sided copies from single sided originals.

⚠ Limitation

You cannot use the following kinds of copy paper with this function:

- Paper smaller than A5, $5\frac{1}{2}'' \times 8\frac{1}{2}''$
- Translucent paper
- Adhesive labels
- OHP transparencies

📝 Note

The following paper limitations apply:

- Metric version

	Single color	Full color
Paper weight	64 - 105g/m ²	
Copy Number Input	B4 or smaller: 50 sheets	A3 - A5: 20 sheets
	A3: 30 sheets	

- Inch version







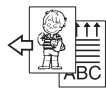

	Single color	Full color
Paper weight	17 - 28 lb	
Copy Number Input	$8\frac{1}{2}'' \times 14''$ or smaller: 50 sheets	$11'' \times 17'' - 5\frac{1}{2}'' \times 8\frac{1}{2}''$: 20 sheets
	$11'' \times 17''$: 30 sheets	

- The image on the backside of copies is shifted by just the binding margin.
- You can change the width and position of the binding margin.
- You can change the default binding margin.

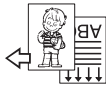
Reference

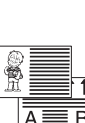
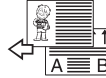
Regarding other functions that cannot be used together with this function, ⇒ P.121 “Combination Chart”.

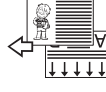
- ◆ The resulting copy image will differ according to the direction in which you place your original (lengthwise  or widthwise .

Originals	Orientation	Result* ¹
		
		
		
		

GCTYTYIE

*1 The illustrations show the directions of copied images on the front and back, not the directions delivery.

1 Press the [Duplex/Combine] key.

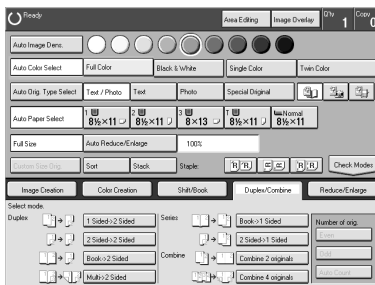

2 Press the [1 Sided → 2 Sided] key.

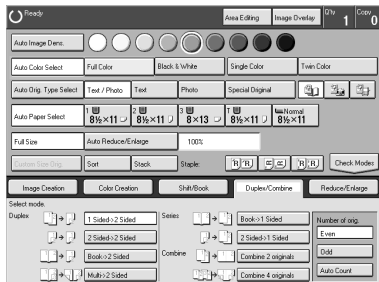

3 Press the [Even] key or the [Odd] key according to the number of your originals.

Note

- When you set an odd number of originals, the back side of the last page is left blank.
- If you do not know the total number of originals, press the [Auto Count] key, and then press the [Start Count] key.

The optional document feeder is required to use Auto Count function.

4 Press the [OK] key.

5 Place your originals in the document feeder, and then press the [Start] key.

2 Sided → 2 Sided

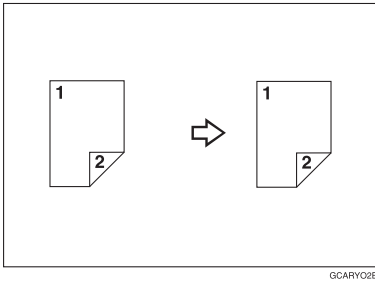

GCARY02E

This function makes double sided copies from double sided originals.

1 Press the [Duplex/Combine] key.

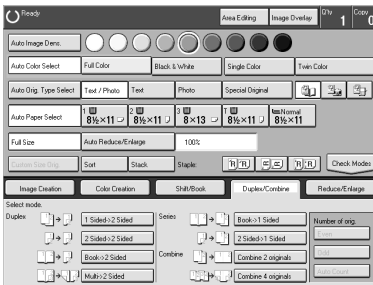

2 Press the [2 Sided → 2 Sided] key.

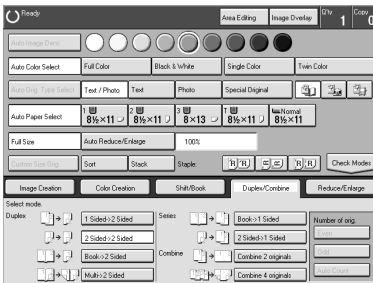

3 Place your originals in the document feeder, and then press the [Start] key.

Book → 2 Sided

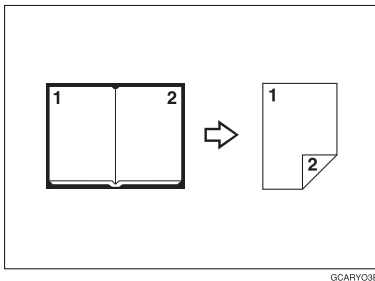







GCARYOSE

Use this feature to copy facing pages of a book or magazine onto both sides of the copy paper.





Note

- Select the lengthwise  copy paper.
- The following table summarizes the relationship between the size of originals and copy paper size for full-size copying (100%).

- Metric version

Original	Copy Paper
A3 	A4  (2-sided)
B4 	B5  (2-sided)
A4 	A5  (2-sided)

- Inch version

Original	Copy Paper
11" × 17" 	8 1/2" × 11"  (2-sided)
8 1/2" × 11" 	5 1/2" × 8 1/2"  (2-sided)

1 Press the [Duplex/Combine] key.

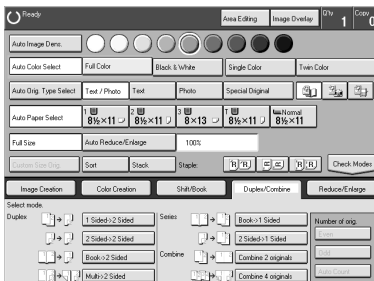

- 2 Select the lengthwise  copy paper.
- 3 Press the [Book → 2 Sided] key.

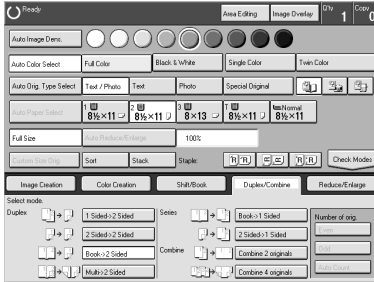

- 4 Place your original on the exposure glass, and then press the [Start] key.

Multi → 2 Sided

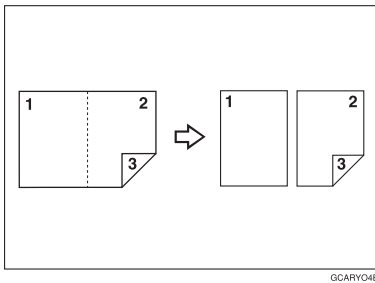







GCARY04E

This function makes one single sided and one double sided copy from a three page pamphlet.





Note

- The following table summarizes the relationship between the size of originals and copy paper size for full-size copying (100%).

- Metric version

Original	Copy Paper
A3 	A4  (2-sided)
B4 	B5  (2-sided)
A4 	A5  (2-sided)

- Inch version

Original	Copy Paper
11" × 17" 	8 ¹ / ₂ " × 11"  (2-sided)
8 ¹ / ₂ " × 11" 	5 ¹ / ₂ " × 8 ¹ / ₂ "  (2-sided)

1 Press the [Duplex/Combine] key.

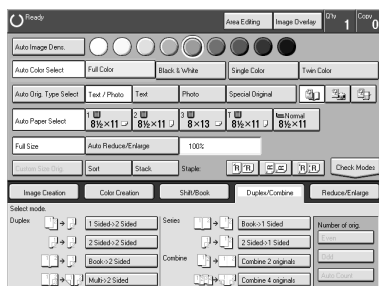

2 Select the lengthwise copy paper.

3 Press the [Multi → 2 Sided] key.

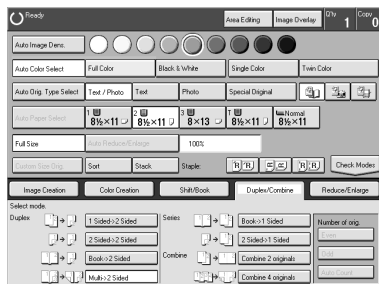

4 Place your originals in the document feeder, and then press the [Start] key.

2

Series Copies

Book → 1 Sided

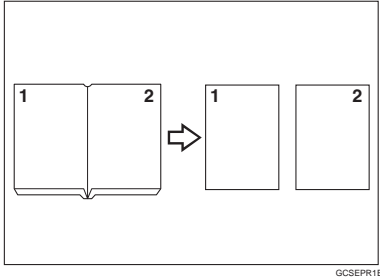

This function makes one-sided copies from two facing pages of bound (book) originals.







Reference

Regarding functions that cannot be used together with this function, ⇒ P.121 "Combination Chart".





Note

The following table summarizes the relationship between the size of originals and copy paper size for full-size copying (100%).

- Metric version

Original	Copy Paper
A3 	A4  × 2 sheets
B4 	B5  × 2 sheets
A4 	A5  × 2 sheets

- Inch version

Original	Copy Paper
11" × 17" 	8 ¹ / ₂ " × 11"  × 2 sheets
8 ¹ / ₂ " × 11" 	5 ¹ / ₂ " × 8 ¹ / ₂ "  × 2 sheets

1 Press the [Duplex/Combine] key.

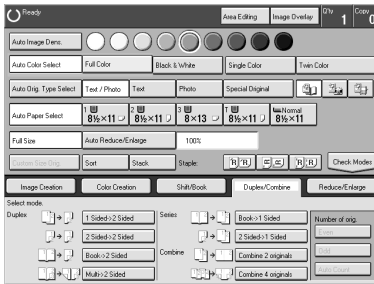

2 Select the lengthwise copy paper.

3 Press the [Book → 1 Sided] key.

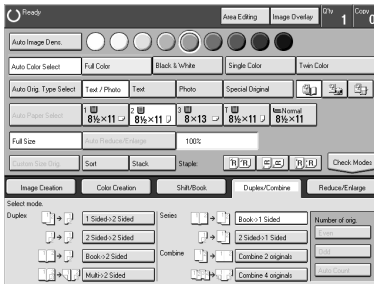

4 Place your originals, and then press the [Start] key.

2

2 Sided → 1 Sided

The optional document feeder is required to use this function.

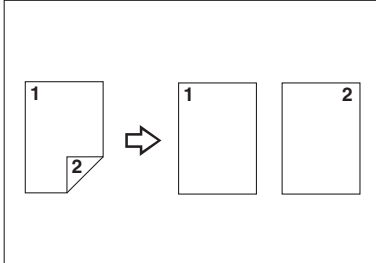

GCSEPRZE

Reference

Regarding other functions that cannot be used together with this function, ⇒ P.121 “Combination Chart”.

1 Press the [Duplex/Combine] key.

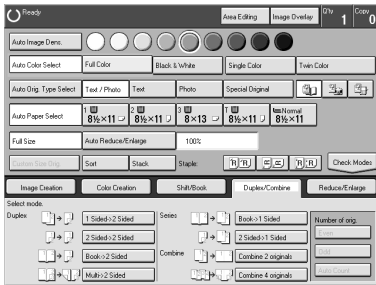

2 Select the lengthwise copy paper.

3 Press the [2 Sided → 1 Sided] key.

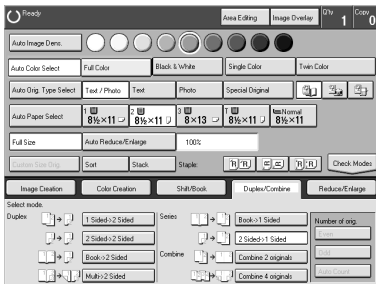

4 Place your originals in the document feeder, and then press the [Start] key.

Combine

Combine 2 Originals

The optional document feeder is required to use this function.

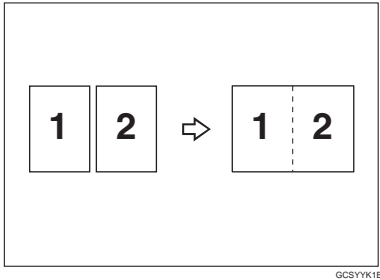

GCSYK1E

This function automatically combines two single sided originals onto one copy.

Note

- If the original size and direction is set differently, you cannot use the combine function.
- When you use the Combine function, Auto Reduce/Enlarge is selected automatically.

Reference

Regarding other functions that cannot be used together with this function, ⇒ P.121 “Combination Chart”.

Setting Originals (Originals set in the document feeder)

- Originals reading from left to right

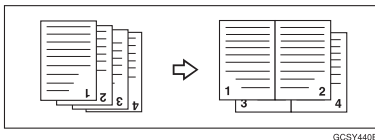

GCSY44GE

- Originals reading from top to bottom

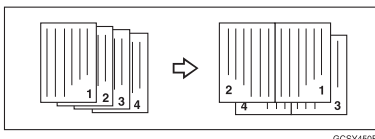

GCSY450E

1 Press the [Duplex/Combine] key.

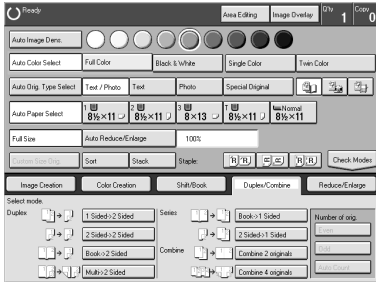

2 Select the widthwise  copy paper.

3 Press the [Combine 2 originals] key.

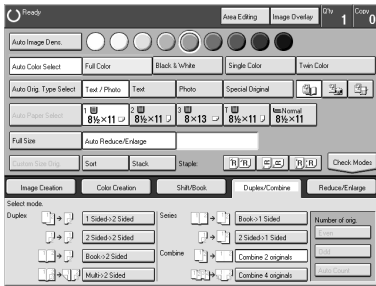

4 Place your originals in the document feeder, and then press the [Start] key.

Combine 4 Originals

The optional document feeder is required to use this function.

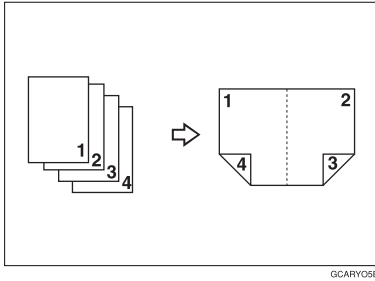

GCARY05E

Reference

Regarding other functions that cannot be used together with this function, ⇒ P.121 “Combination Chart”.

1 Press the [Duplex/Combine] key.

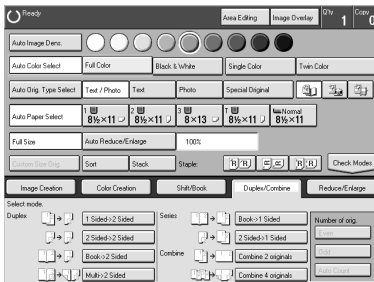

2 Select the wide copy paper.

3 Press the [Combine 4 originals] key.

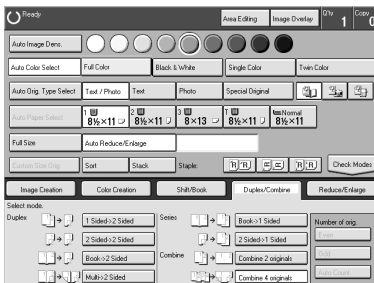

4 Place your originals in the document feeder, and then press the [Start] key.

Shifting the Image

Shift

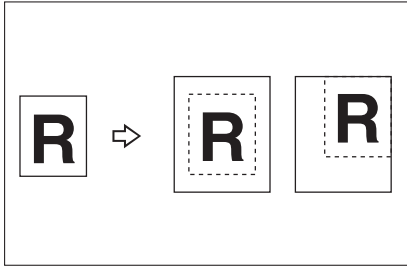

GC10H3E

You can move the image to a corner or edge as well as center it. This function is useful when the copy paper is larger than the original.

Note

- When you copy onto 12" × 18", 13" × 19" size copy paper, the original image is copied onto the center.

1 Press the [Shift/Book] key.

2 Press the [Shift] key.

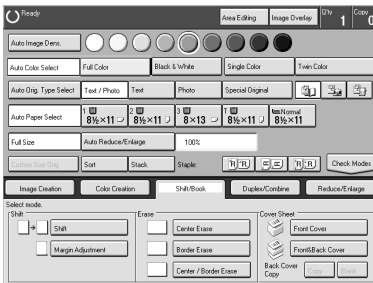

3 Select the direction in which you want to shift the image.

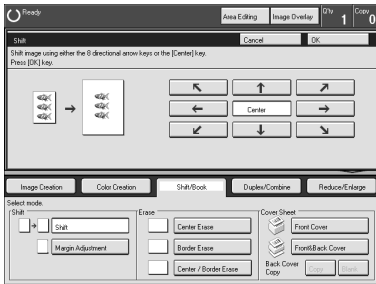

Note

- When you want to center the image, press the **[Center]** key.

4 Press the **[OK]** key.

5 Select the copy paper size.

6 Place your originals, and then press the **[Start]** key.

Margin Adjustment

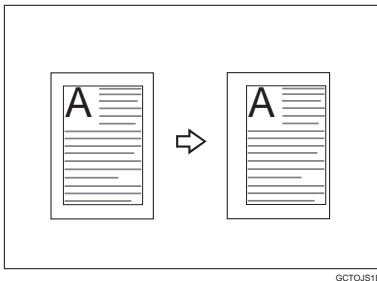

You can make a margin by shifting the image to the left or right. This function is useful when you want to bind copies.

Note

- You can change the width of the binding margin as follows:

Metric Version	0 - 20mm (in 1mm steps)
Inch Version	0" - 0.8" (in 0.1" steps)

- The margin width default is as follows. You can change this default setting with the user tools. ⇒ P.217 “General Features”.

Metric Version	<ul style="list-style-type: none"> • Front: 0mm Left • Back: 0mm Right
Inch Version	<ul style="list-style-type: none"> • Front: 0" Left • Back: 0" Right

- If you set too wide a margin, areas you do not want to delete might be erased.

Reference

Regarding other functions that cannot be used together with this function, ⇒ P.121 “Combination Chart”.

1 Press the [Shift/Book] key.

2 Press the [Margin Adjustment] key.

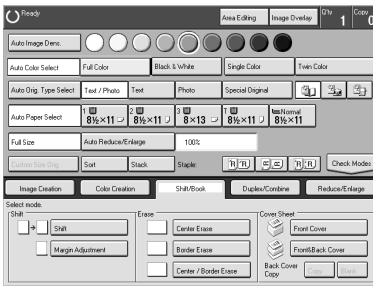

3 Enter the margins for the front side and back side of the copy paper.

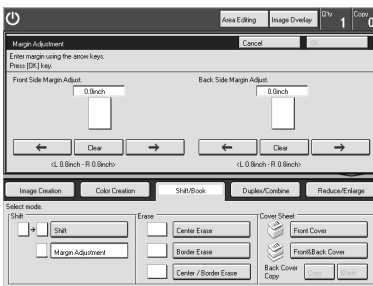

Note

- To change the value entered, press the [Clear] key and enter a new value.
- To make a left margin, press the [→] key until the number displayed reaches the required setting.
- To make a right margin, press the [←] key until the number displayed reaches the required setting.

4 Press the **[OK]** key.

5 Place your originals, and then press the **[Start]** key.

Erase

Center Erase

2

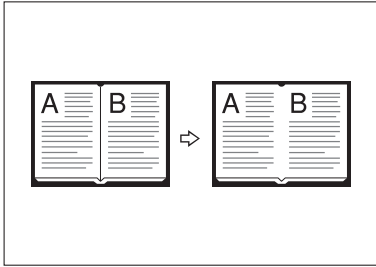

GCCENT1E

Border Erase

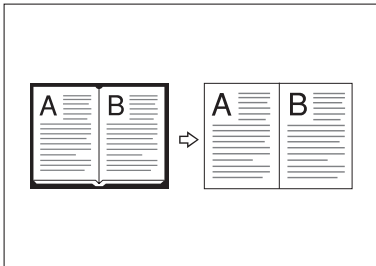

GCCENT2E

Center/Border Erase

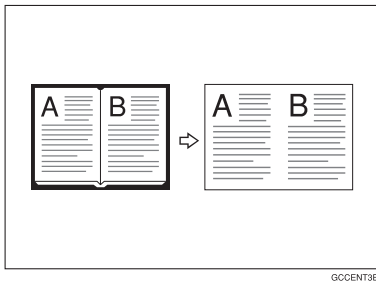

Reference

Regarding other functions that cannot be used together with these functions,
⇒ P.121 "Combination Chart".

Note

- The position of the margin to be erased is determined according to the original size and reproduction ratio.

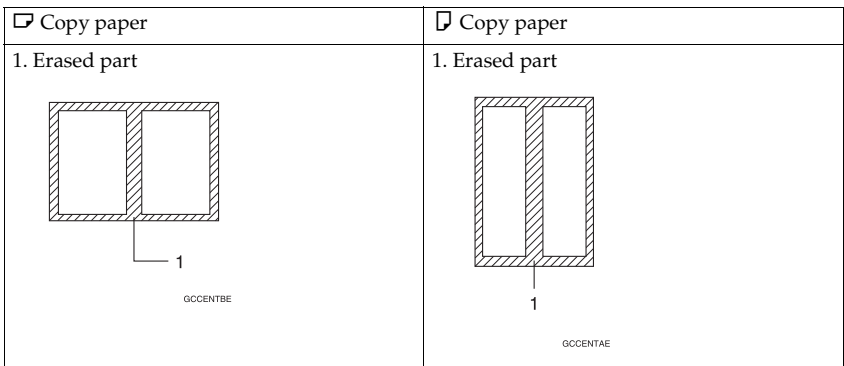

1 Press the [Shift/Book] key.

2 Press the [Center Erase], [Border Erase], or [Center / Border Erase] key.

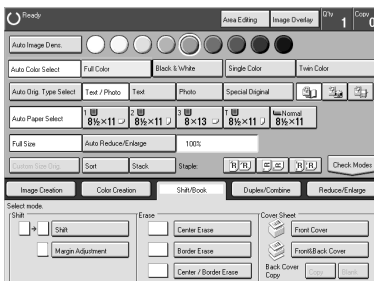

3 Adjust the width of the margin to be erased by pressing the **[+]** or **[-]** key.

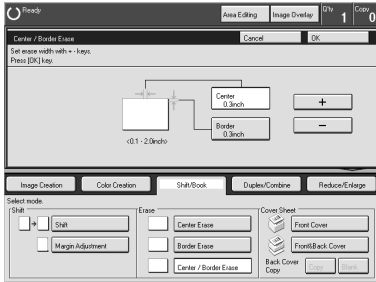

Note

You can adjust the width in the range of 3 - 50mm, 0.1" - 2.0".

4 Press the **[OK]** key.

5 Place your originals, and then press the **[Start]** key.

Cover Sheet

Front Cover

The optional document feeder is required to use this function.

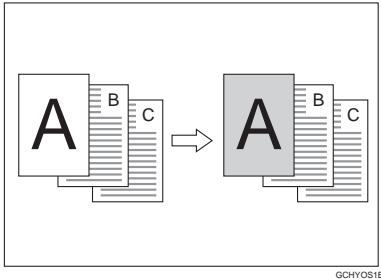

GCHY051E

Note

- The cover sheets should be identical in size and direction with the copy paper.
- The cover sheets should be fed from the bypass tray.
- The covers are copied in Thick or Extra Thick mode.

Reference

Regarding other functions that cannot be used together with this function, ⇒ P.121 “Combination Chart”.

When you use front cover mode with 1 Sided → 1 Sided mode

1 Press the [Shift/Book] key.

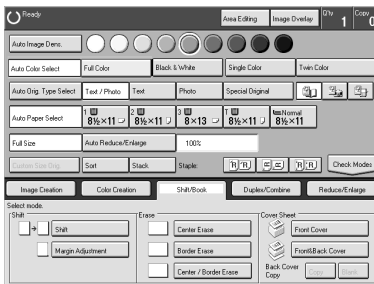

2 Press the [Front Cover] key.

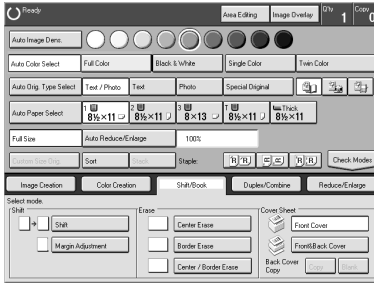

3 Place your originals in the document feeder, and then press the [Start] key.

When you use front cover mode with 2 Sided → 1 Sided or 2 Sided → 2 Sided mode

1 Enter 2 Sided→1 Sided or 2 Sided→2 Sided mode. ⇒ P.72 “2 Sided →2 Sided” or ⇒ P.78 “2 Sided →1 Sided”.

2 Follow the steps **1** to **2** on ⇒ P.89 “When you use front cover mode with 1 Sided →1 Sided mode”.

3 Select [Image] or [Blank] key depending on whether the reverse side of first original has an image or not.

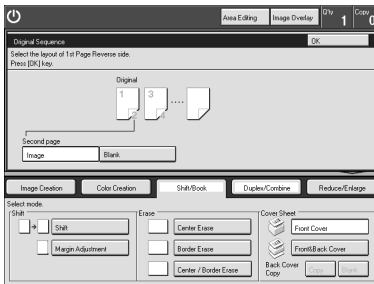

4 Press the [OK] key.

5 Place your originals in the document feeder, and then press the [Start] key.

Front & Back Cover

The optional document feeder is required to use this function.

◆ Back Cover: Copy

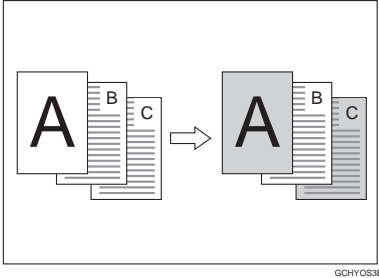

◆ Back Cover: Blank

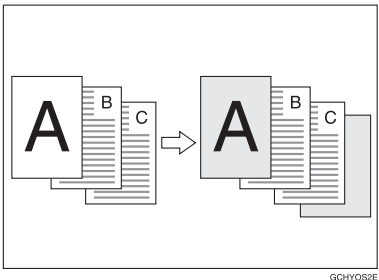

Note

- You can specify whether to copy onto the back cover sheet. If you select **[Copy]**, the last pages will be copied on the back cover sheets. If you select **[Blank]**, a cover sheet will just be inserted after the last copy.
- The cover sheets should be identical in size and direction to the copy paper.
- The cover sheets should be fed from the bypass tray.
- The covers are copied in Thick or Extra Thick mode.
- If Blank Cover mode is selected, the back cover will not be counted as a copy.

Reference

Regarding other functions that cannot be used together with this function, ⇒ P.121 "Combination Chart".

When you use the front & back covers mode with the 1 Sided → 1 Sided mode

1 Press the [Shift/Book] key.

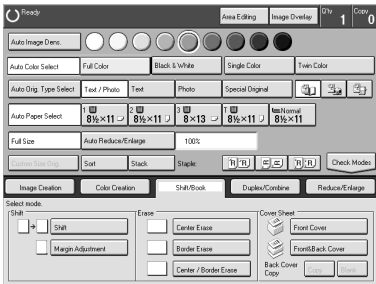

2 Press the [Front&Back Cover] key.

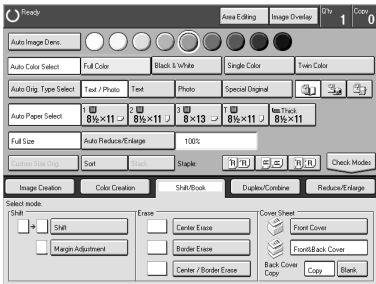

3 Select the [Copy] or [Blank] key to choose whether to copy onto the back cover.

4 Place your originals in the document feeder.

5 Press the [Start] key.

When you use the front & back covers mode with the 2 Sided → 1 Sided or 2 Sided → 2 Sided mode

1 Enter 2 Sided→1 Sided or 2 Sided→2 Sided mode. ⇒ P.72 "2 Sided → 2 Sided" or ⇒ P.78 "2 Sided → 1 Sided".

2 Follow the steps **1** to **5** in the previous procedure.

- 3** Press the [Image] or [Blank] key depending on whether the reverse side of the first original has an image or not.

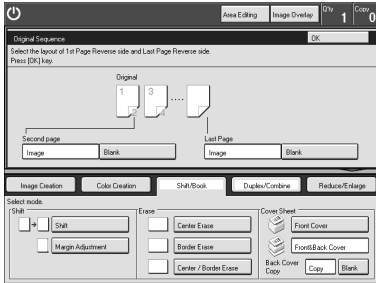

- 4** Press the [Image] or [Blank] key depending on whether the reverse side of the last original has an image or not.
- 5** Press the [OK] key.
- 6** Follow the steps **4** and **5** in the previous procedure.

Color Creation

Color Conversion

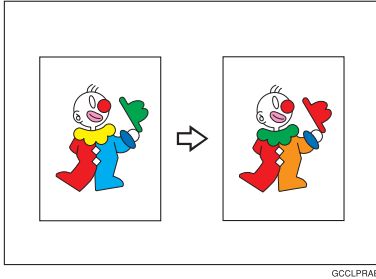

This function converts selected colors of an original into different colors on the copy.

Note

- Up to 4 colors can be converted at one time.
- Colors you can convert: Yellow, Red, Magenta, Green, Cyan, Blue, Black, White, and Scanned Color (option)
- Only one Scanned Color can be selected at a time.
- Colors that can be converted to: Yellow, Orange, Red, Magenta, Green, Cyan, Blue, Yellow Green, Black, White, Beige, Pink, Marine Blue, Purple, User colors, and Scanned Color (option)
- This function can be made more or less sensitive to the color to be converted. It can be adjusted within five levels from "Narrow" to "Wide". ⇒ P.142 "Image Adjustment". For example, if red is selected as the color to be converted, "Narrow" will result in only red being converted, and "Wide" will result in other colors close to red being converted.
- This function can be used in Full Color mode.
- When using Color Conversion and Color Erase together, you can only choose Scanned Color (option) for one of these functions.

1 Press the [Color Creation] key.

2 Press the [Color Conversion] key.

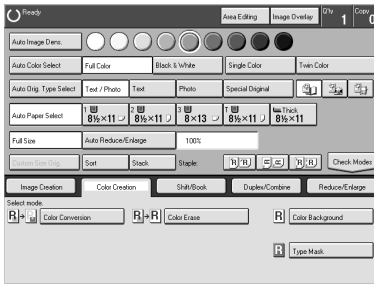

2

3 Select the original color (color to be converted).

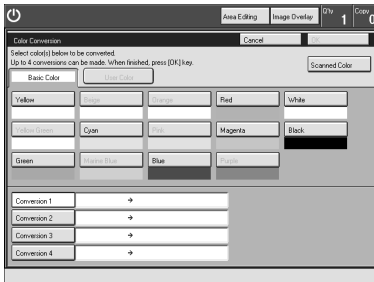

4 Select the new color (color to convert to).

5 If you want to convert more than one color, repeat steps 3 and 4.

Note

- If you pick the wrong color, press the [Clear] key.

6 Press the [OK] key.

7 Place your originals, and then press the [Start] key.

Color Erase

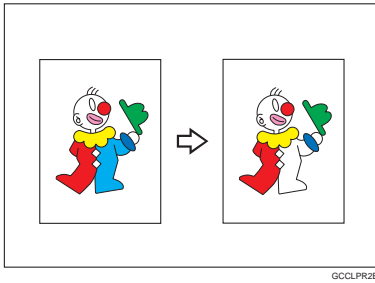

This function erases selected colors from the original image.

Note

- Up to 4 colors can be erased at one time.
- Colors that can be erased: Yellow, Red, Magenta, Green, Cyan, Blue, Black, and Scanned Color (option)
- Only one Scanned Color can be selected at a time.
- This function can be made more or less sensitive to the color to be erased. It can be adjusted within five levels from "Narrow" to "Wide". ⇒ P.142 "Image Adjustment". For example, if red is selected as the color to be erased, "Narrow" will result in only red being erased, and "Wide" will result in other colors close to red being erased.
- When using Color Erase and Color Conversion together, you can only choose Scanned Color (option) for one of these functions.

1 Press the [Color Creation] key.

2 Press the [Color Erase] key.

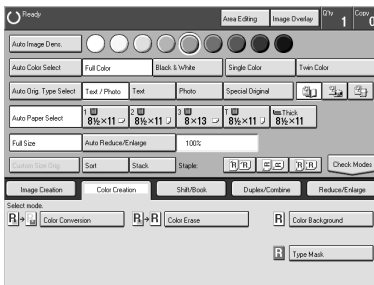

3 Select the color to be erased.

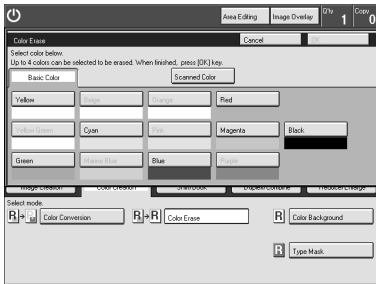

4 Press the [OK] key

5 Place your originals, and then press the [Start] key.

Color Background

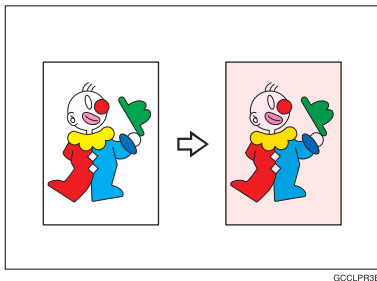

GCCLPR3E

This function makes copies with the selected color background.

Note

- Colors that can be selected as a background color: Yellow, Orange, Red, Magenta, Green, Cyan, Blue, Yellow Green, Black, Beige, Pink, Marine Blue, Purple, Scanned Color (option), and User Colors
- In this mode, color tones of photos or pictures might be changed depending on the color on the background.

1 Press the [Color Creation] key.

2 Press the [Color Background] key.

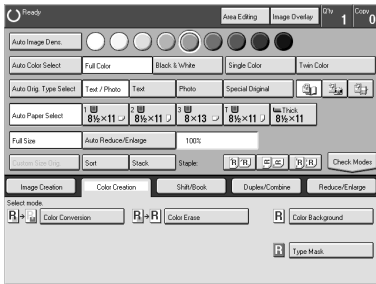

3 Select the color for background.

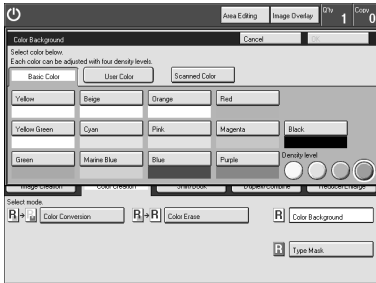

Note

You can select the color density level.

4 Press the [OK] key

5 Place your originals, and then press the [Start] key.

Type Mask

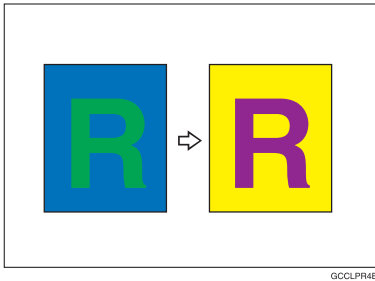

This function copies the colored text part and background part separately.

Note

- When the machine is not able to differentiate between the text color/images and the background, the background is copied using the specified text color.
- Colors that can be selected as a Text (image) and background color: Yellow, Magenta, Cyan, Green, Red, Orange, Marine Blue, Beige, Yellow Green, Pink, Purple, Black, White, Scanned Color (option), and User Colors

1 Press the [Color Creation] key.

2 Press the [Type Mask] key.

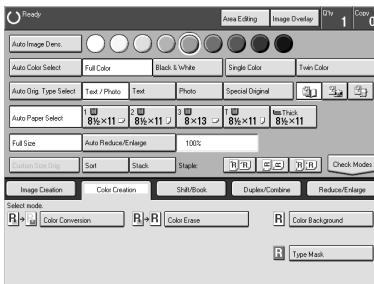

3 Press the [Background] key.

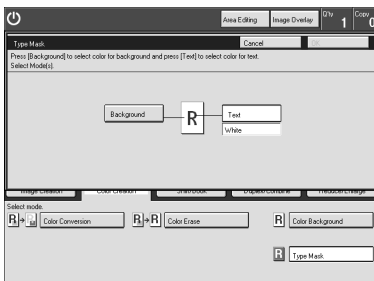

4 Select the color for the background, and then press the [OK] key.

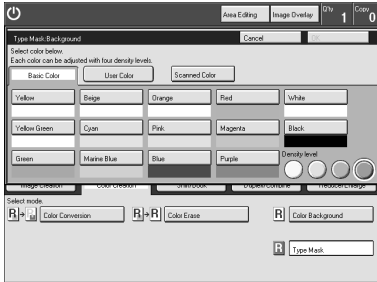

Note

□ You can select the color density level.

5 Press the [Text] key and select the color for the text.

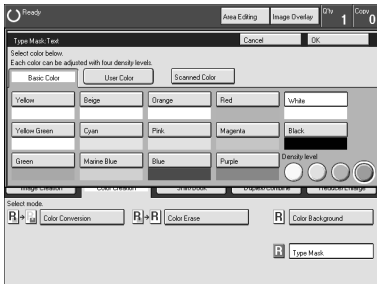

Note

□ You can select the color density level.

6 Press the [OK] key.

7 Place your originals, and then press the [Start] key.

Image Creation

Outline Image

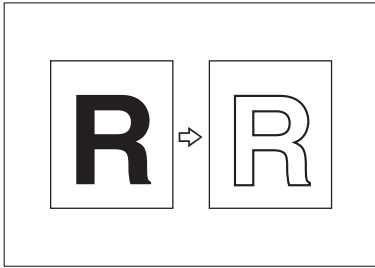

GCNKA1E

This function copies only the outline of the image.

Note

- This function is copied in Auto Image Density and Auto Original Type Select mode.
- Colors that can be selected as an outline color: Yellow, Orange, Red, Magenta, Green, Cyan, Blue, Yellow Green, Black, Beige, Pink, Marine Blue, Purple, Scanned Color (option), and User Colors.

1 Press the [Image Creation] key.

2 Press the [Outline Image] key.

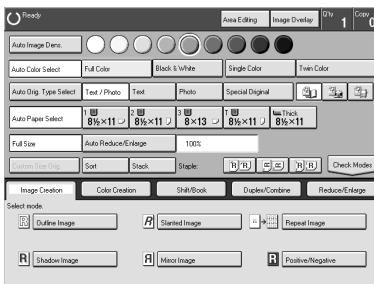

3 Select the width of the outline.

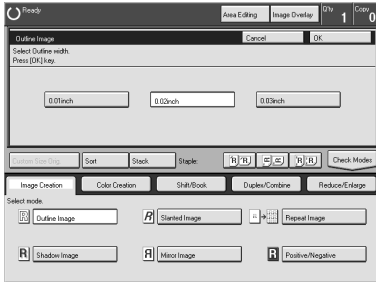

4 Press the [OK] key.

5 Place your originals, and then press the [Start] key.

Shadow Image

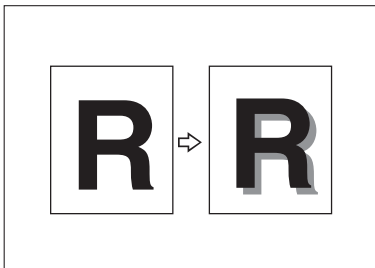

GKKA6E1E

This function adds a shadow around the edges of copy image elements. You can select block shadow or offset shadow.

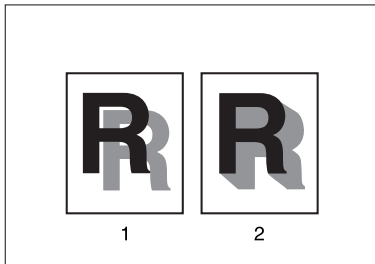

GKKA6E2E

1. Offset
2. Block

The orientation of the original decides the position of the shadow as follows:

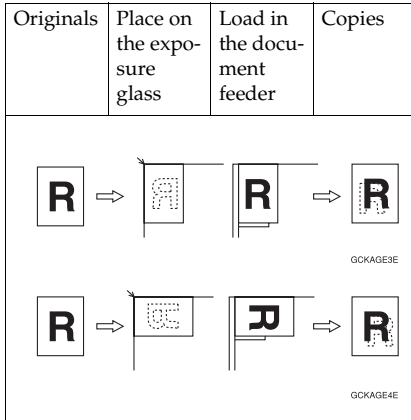

Note

- You can select the color of shadow as follows:
 - Same Color: A shadow of the same color as the original is added.
 - Select Color: You can select the color of the shadow.
- Shadow widths:
 - Metric version: 1mm, 2mm, 3mm, 4mm
 - Inch version: 0.04", 0.08", 0.12", 0.16"

Same color shadow

1 Press the [Image Creation] key.

2 Press the [Shadow Image] key.

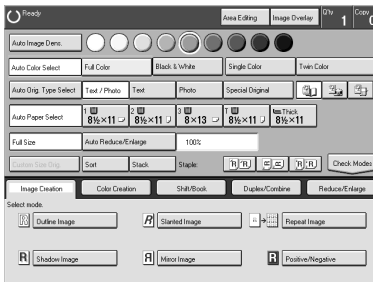

3 Press the [Block] or [Offset] key.

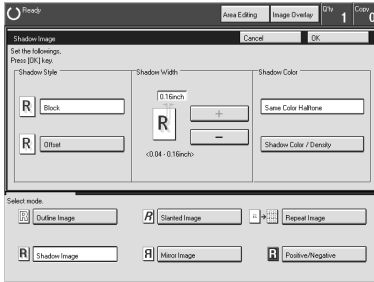

4 Adjust the width by pressing the [+] or [-] key.

5 Make sure the [Same Color Halftone] key is selected.

6 Press the [OK] key.

7 Place your originals, and then press the [Start] key.

Select color shadow

1 Press the [Image Creation] key.

2 Press the [Shadow Image] key.

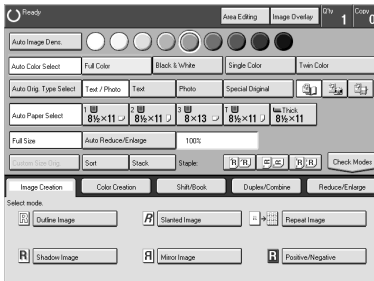

3 Press the [Block] or [Offset] key.

4 Adjust the width by pressing the [+] or [-] key.

5 Press the [Shadow Color / Density] key.

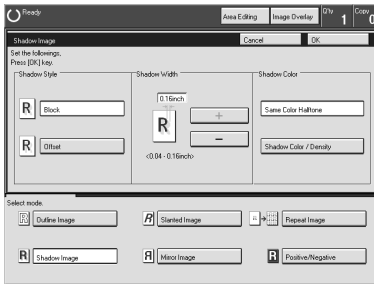

6 Select the color, and then press the [OK] key.

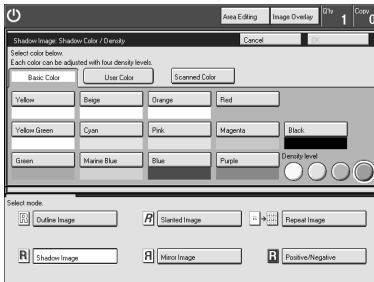

Note

You can select the color density level.

7 Press the [OK] key.

8 Place your originals, and then press the [Start] key.

2

Slanted Image

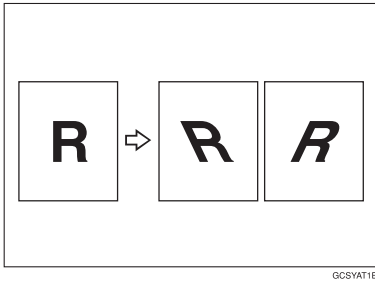

This function slants the copy image at a selected angle.

Note

- The slant direction is decided as shown in the illustration:

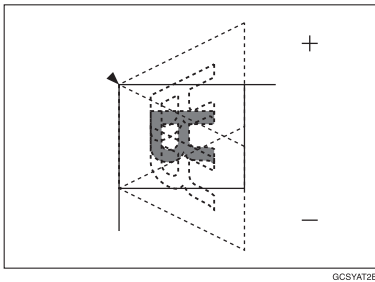

- You can select the angle from -45° to $+45^\circ$.
- Depending on the angle, some parts of the image may be lost.

1 Press the [Image Creation] key.

2 Press the [Slanted Image] key.

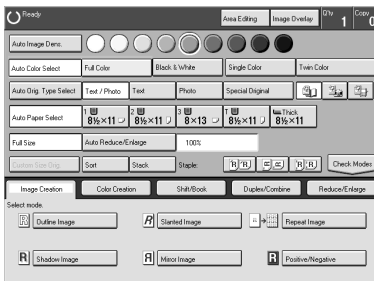

3 Adjust the angle by pressing the arrow keys.

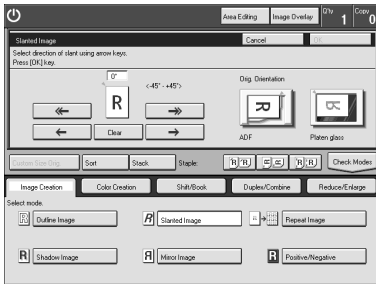

Note

- By pressing the [**←**] or [**→**] key, the number of the angle can be adjusted by in steps of 5°.
- By pressing the [**↶**] or [**↷**] key, the number of the angle can be adjusted by in steps of 1°.
- To cancel the angle, press the [**Clear**] key.

4 Press the [OK] key.

5 Place your originals, and then press the [Start] key.

Mirror Image

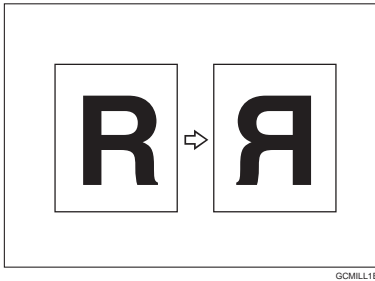

GCMILL1E

This function makes a mirror image copy of the original.

Note

- Place the original on the exposure glass as shown.

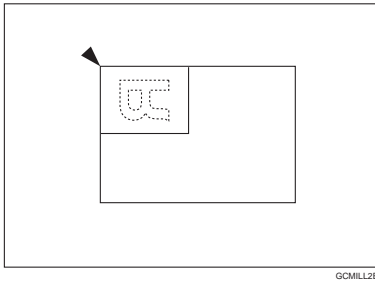

GCMILL2E

1 Press the [Image Creation] key.

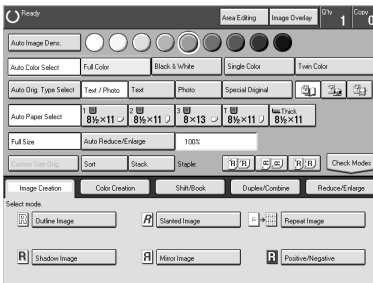

2 Press the [Mirror Image] key.

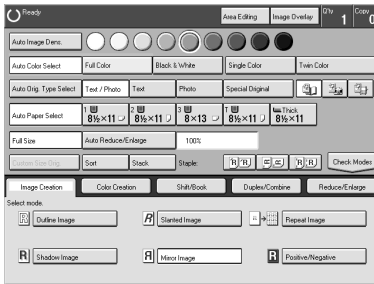

3 Place your originals, and then press the [Start] key.

Repeat Image

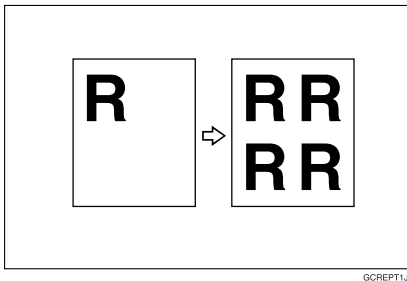

GCREPT1J

This function copies a part of the original image repeatedly.

Note

- When this function is used, the leading edge margin of 10mm, 0.4" is set on the copy paper.
- There are three ways to specify the image of the original to be repeated as follows:
 - **D.Size Mag.(inch):**
This function allows you to reproduce the top band of an original repeatedly down the entire copy. You specify the width of the band (the vertical length of image) and it is repeated as many times as will fit on the copy.
 - **Number of Images:**
This function also allows you to reproduce the top band of an original repeatedly down the entire copy, but here you specify the number of image repetitions you want and the copier will determine the width of the top band.
 - **Editor Area:**
This function allows you to select an area of the original and reproduce it repeatedly down the copy. The repetitions are made one below the other, and are all aligned to the right.

- For an explanation about entering numbers, ⇒ P.10 “Entering Numbers”.
- The number of repeated images that can be fit on a single sheet of copy paper is calculated automatically based upon the copy paper size, copy paper direction and enlargement/reduction ratio.
- Depending on the copy paper size, copy paper direction and enlargement/reduction ratio, parts of repeated images may be cut off.
- When using the D.Size Mag.(inch) key or the Editor Area key, parts of some repeated images may be cut off depending on the values you enter.

2

When using the [D.Size Mag.(inch)] key

1 Press the [Image Creation] key.

2 Press the [Repeat Image] key.

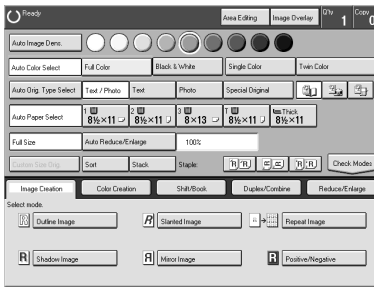

3 Press the [D.Size Mag.(inch)] key.

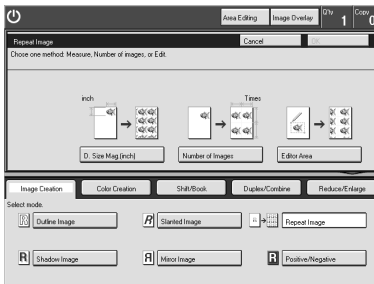

- 4** Enter the horizontal and vertical length with the number keys, and then press the [#] key.

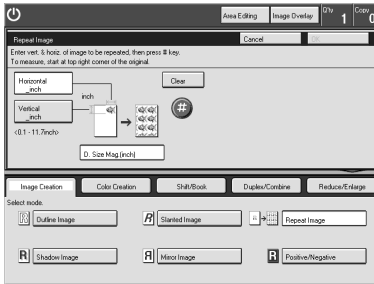

Note

- The length that you can enter is 1 - 300mm, 0.1" - 11.7". When you enter less than 5mm, 0.2", the image might not be repeated well.

- 5** Press the [OK] key.
- 6** Place your originals, and then press the [Start] key.

When using the [Number of Images] key

- 1** Select the copy paper size.
- 2** Press the [Image Creation] key.
- 3** Press the [Repeat Image] key.

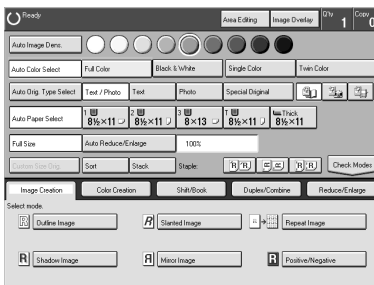

4 Press the [Number of Images] key.

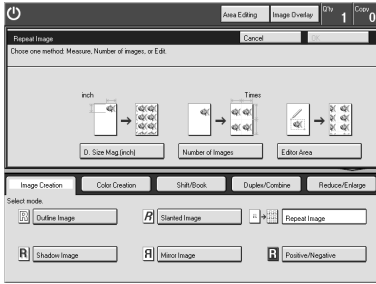

5 Enter a horizontal and vertical number between 1 and 15, and then press the [#] key.

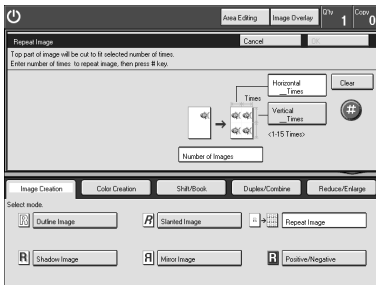

Note

❑ If the horizontal and vertical settings are 1×1 , you cannot press the [#] key.

6 Press the [OK] key.

7 Place your originals, and then press the [Start] key.

When using the [Editor Area] key

1 Press the [Image Creation] key.

2 Press the [Repeat Image] key.

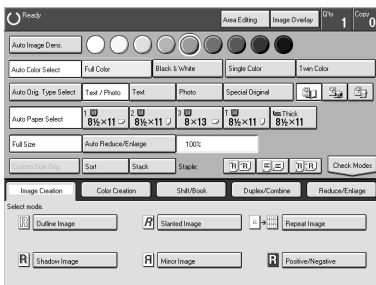

- 3** Place your original on the exposure glass, and then press the [Editor Area] key.

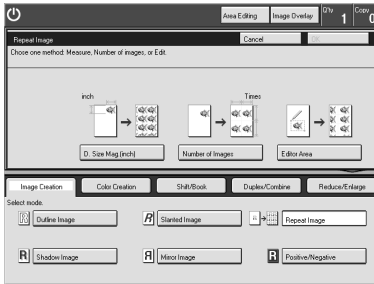

⚠ Limitation

- You cannot load your originals in the document feeder.

- 4** Diagonally mark opposite corners of area to be repeated.

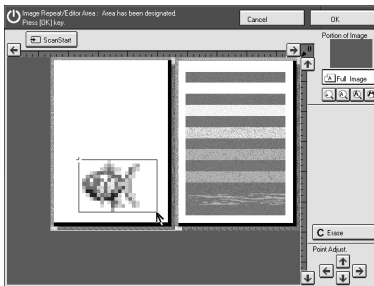

📝 Note

- The area you have designated is scanned in.
- For details about designating the area, ⇒ P.153 "Designating Areas".

- 5** Press the [OK] key.

- 6** Press the [Start] key.

Positive/Negative

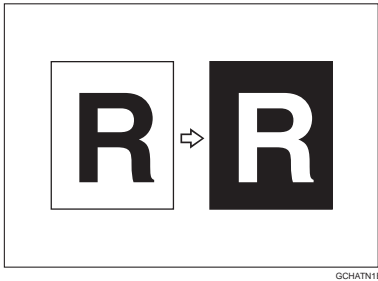

This function copies the original image in complementary colors. If you use a black and white original, black and white areas of the original are reversed.

Note

- If you copy using twin color mode, white areas are changed to black, black areas are changed to white, and color areas are changed to the selected color.
- If you copy using the Twin Color mode (Red & Black Copy), white areas are changed to black, black areas are changed to white or red areas are copied as red.

1 Press the [Image Creation] key.

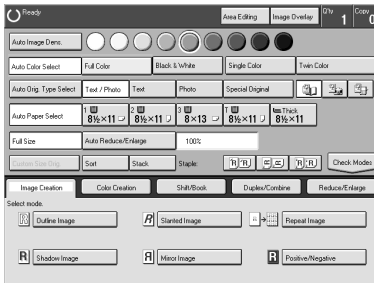

2 Press the [Positive/Negative] key.

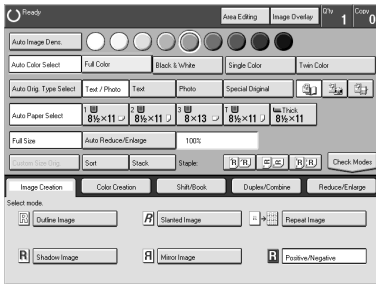

3 Place your originals, and then press the [Start] key.

2

Finishing

Note

- To avoid problems caused by curled copies, try turning over the paper stack in the paper tray. If there is no improvement, change to copy paper with less curl.

Reference

Regarding other functions that cannot be used together with this function, ⇒ P.121 "Combination Chart".

Sort

The optional 20-bin sorter stapler is required to use this function.

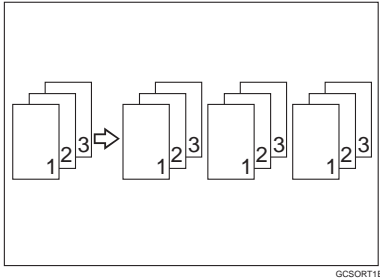

One copy of each original is delivered to each bin and copies are collated into sets.

Note

- It is recommended to load originals in the document feeder with this function.
- For sorting, the following limitations apply:

	Normal mode	Thick mode	Extra Thick mode
Maximum paper size	☐: A3, 13" × 19" ☒: A4, 8 ¹ / ₂ " × 11"	☐: A3, 13" × 19" ☒: A4, 8 ¹ / ₂ " × 11"	☐: A3, 13" × 19" ☒: A4, 8 ¹ / ₂ " × 11"
Minimum paper size	☐: B5, 8" × 10" ☒: B5, 8 ¹ / ₂ " × 11"	☐: B5, 8" × 10" ☒: B5, 8 ¹ / ₂ " × 11"	☐: B5, 8" × 10" ☒: B5, 8 ¹ / ₂ " × 11"
Maximum paper capacity of bin	50 copies	30 copies	20 copies

- You cannot use OHP transparencies or custom size paper in Sort mode.
- You can make the machine select Sort mode automatically, when you insert two or more originals in the document feeder and make two or more copies from each original. ⇒ P.223 "Duplex/ADF/Sorter".

1 Press the [Sort] key.

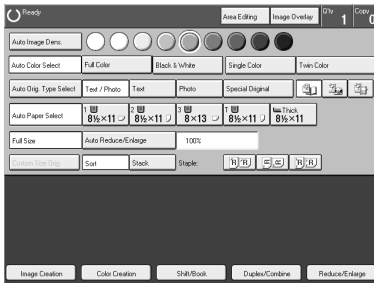

2 Load your originals in the document feeder.

3 Press the [Start] key.

Stack

The optional 20-bin sorter stapler is required to use this function.

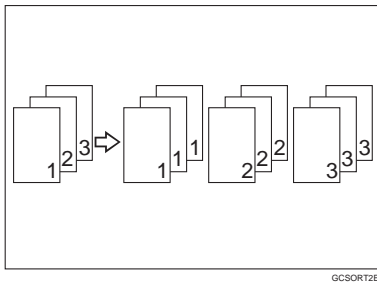

GCSORT2E

All copies of each original are delivered to the same bin.

Note

For stacking, the following limitations apply:

	Normal mode	Thick mode	Extra Thick mode
Maximum paper size	☐: A3, 13" × 19" ☒: A4, 8 ¹ / ₂ " × 11"	☐: A3, 13" × 19" ☒: A4, 8 ¹ / ₂ " × 11"	☐: A3, 13" × 19" ☒: A4, 8 ¹ / ₂ " × 11"
Minimum paper size	☐: B5, 8" × 10" ☒: B5, 8 ¹ / ₂ " × 11"	☐: B5, 8" × 10" ☒: B5, 8 ¹ / ₂ " × 11"	☐: B5, 8" × 10" ☒: B5, 8 ¹ / ₂ " × 11"
Maximum paper capacity of bin	50 copies	30 copies	20 copies

You cannot use OHP transparencies or custom size paper in Sort mode.

1 Press the [Stack] key.

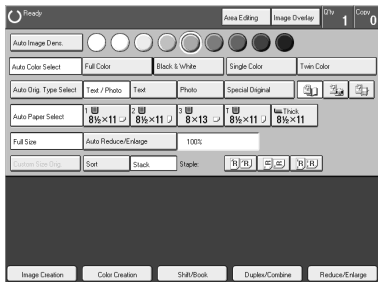

2 Load your originals in the document feeder.

3 Press the [Start] key.

Staple

The optional 20-bin sorter stapler is required to use this function.

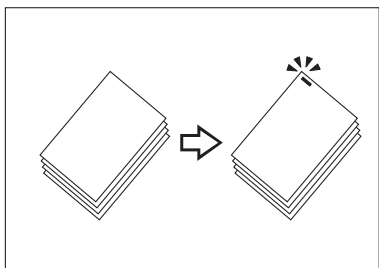

GCSORT3E

Each copy set can be stapled together.

Note

- Since the image is rotated, if the direction of the original and paper direction differ, the staples might not be in the desired position.
- When you select Staple mode, Sort mode is automatically selected.
- You cannot use Staple mode with Stack mode.
- You cannot use OHP transparencies or custom size paper in Staple mode.
- You cannot staple different widths of paper.

- The relationship between the orientation in which the original is placed and the stapling position is shown below.

	Original setting		Stapling position
	Exposure glass	Document feeder	
Top 1			
Top 2			
Double			

GCSX140E

- For stapling, the following limitations apply:

	Normal mode	Thick mode	Extra Thick mode
Maximum paper size	☐: A3, 13" × 19" ☒: A4, 8 ¹ / ₂ " × 11"	☐: A3, 13" × 19" ☒: A4, 8 ¹ / ₂ " × 11"	☐: A3, 13" × 19" ☒: A4, 8 ¹ / ₂ " × 11"
Minimum paper size	☐: B5, 8" × 10" ☒: B5, 8 ¹ / ₂ " × 11"	☐: B5, 8" × 10" ☒: B5, 8 ¹ / ₂ " × 11"	☐: B5, 8" × 10" ☒: B5, 8 ¹ / ₂ " × 11"
Stapler capacity (80 g/m ² , 20lb)	2-50 copies	2-25 copies	2-10 copies

Reference

If you want to add staples, ⇒ P.201 “ Adding Staples”.

When the stapler is jammed, ⇒ P.203 “ Removing Jammed Staples”.

Having copies stapled automatically after copying

The optional document feeder is required to use this function.

1 Select the stapling position.

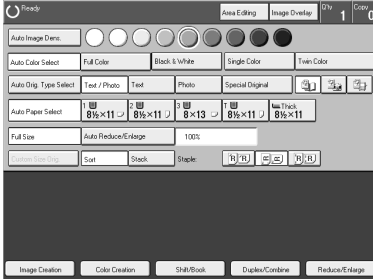

2 Load your originals in the document feeder.

3 Press the **[Start]** key.

Stapling copies manually after copying

1 After Sort mode copying is completed, select the stapling position.

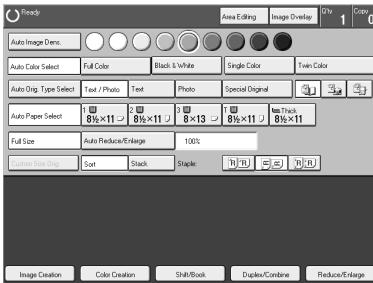

Combination Chart

☆: Those modes can be used together.

★: Those modes can be used together with some limitations.

→: The original mode is overridden and the newly selected mode is active.

✗: These modes cannot be used together.

	Auto Image Density	Manual Image Density	Auto Color Select	Full Color	Black & White	Single Color	Twin Color	Auto Original Type Select	Original Image Type Selection	Auto Paper Select	Auto Reduce/Enlarge	Interrupt Copying	Program	Bypass Tray Copying/Duplex Back	Sort	Stack	Auto Staple	Manual Staple	Custom Size Original	Preset Reduce/Enlarge/Zoom	Size Magnification	Directional Magnification	Poster Mode	Centering/Cornering	Margin Adjustment	Center Erase	Center/Border Erase	Border Erase
Image Density	☆	☆	☆	☆	☆	☆	☆	☆	☆	☆	☆	☆	☆	☆	☆	☆	☆	☆	☆	☆	☆	☆	☆	☆	☆	☆	☆	☆
Color Mode	✗	☆	☆	☆	☆	☆	☆	☆	☆	☆	☆	☆	☆	☆	☆	☆	☆	☆	☆	☆	☆	☆	☆	☆	☆	☆	☆	☆
Auto Original Type Select	☆	☆	☆	☆	☆	☆	☆	☆	☆	☆	☆	☆	☆	☆	☆	☆	☆	☆	☆	☆	☆	☆	☆	☆	☆	☆	☆	☆
Original Image Type Selection	☆	☆	☆	☆	☆	☆	☆	☆	☆	☆	☆	☆	☆	☆	☆	☆	☆	☆	☆	☆	☆	☆	☆	☆	☆	☆	☆	☆
Auto Paper Select	☆	☆	☆	☆	☆	☆	☆	☆	☆	☆	☆	☆	☆	☆	☆	☆	☆	☆	☆	☆	☆	☆	☆	☆	☆	☆	☆	☆
Auto Reduce/Enlarge	☆	☆	☆	☆	☆	☆	☆	☆	☆	☆	☆	☆	☆	☆	☆	☆	☆	☆	☆	☆	☆	☆	☆	☆	☆	☆	☆	☆
Interrupt Copying	☆	☆	☆	☆	☆	☆	☆	☆	☆	☆	☆	☆	☆	☆	☆	☆	☆	☆	☆	☆	☆	☆	☆	☆	☆	☆	☆	☆
Program	☆	☆	☆	☆	☆	☆	☆	☆	☆	☆	☆	☆	☆	☆	☆	☆	☆	☆	☆	☆	☆	☆	☆	☆	☆	☆	☆	☆
Bypass Tray Copying/Duplex Back	☆	☆	☆	☆	☆	☆	☆	☆	☆	☆	☆	☆	☆	☆	☆	☆	☆	☆	☆	☆	☆	☆	☆	☆	☆	☆	☆	☆
Finishing	☆	☆	☆	☆	☆	☆	☆	☆	☆	☆	☆	☆	☆	☆	☆	☆	☆	☆	☆	☆	☆	☆	☆	☆	☆	☆	☆	☆
Sort	☆	☆	☆	☆	☆	☆	☆	☆	☆	☆	☆	☆	☆	☆	☆	☆	☆	☆	☆	☆	☆	☆	☆	☆	☆	☆	☆	☆
Stack	☆	☆	☆	☆	☆	☆	☆	☆	☆	☆	☆	☆	☆	☆	☆	☆	☆	☆	☆	☆	☆	☆	☆	☆	☆	☆	☆	☆
Staple	☆	☆	☆	☆	☆	☆	☆	☆	☆	☆	☆	☆	☆	☆	☆	☆	☆	☆	☆	☆	☆	☆	☆	☆	☆	☆	☆	☆
Custom Size Original	☆	☆	☆	☆	☆	☆	☆	☆	☆	☆	☆	☆	☆	☆	☆	☆	☆	☆	☆	☆	☆	☆	☆	☆	☆	☆	☆	☆
Reduce/Enlarge	☆	☆	☆	☆	☆	☆	☆	☆	☆	☆	☆	☆	☆	☆	☆	☆	☆	☆	☆	☆	☆	☆	☆	☆	☆	☆	☆	☆
Preset Reduce/Enlarge/Zoom	☆	☆	☆	☆	☆	☆	☆	☆	☆	☆	☆	☆	☆	☆	☆	☆	☆	☆	☆	☆	☆	☆	☆	☆	☆	☆	☆	☆
Size Magnification	☆	☆	☆	☆	☆	☆	☆	☆	☆	☆	☆	☆	☆	☆	☆	☆	☆	☆	☆	☆	☆	☆	☆	☆	☆	☆	☆	☆
Directional Magnification	☆	☆	☆	☆	☆	☆	☆	☆	☆	☆	☆	☆	☆	☆	☆	☆	☆	☆	☆	☆	☆	☆	☆	☆	☆	☆	☆	☆
Poster Mode	☆	☆	☆	☆	☆	☆	☆	☆	☆	☆	☆	☆	☆	☆	☆	☆	☆	☆	☆	☆	☆	☆	☆	☆	☆	☆	☆	☆

3. Image Overlay (Option)

What is Image Overlay?

If your machine has the optional editing kit, you can overlay a portion of the foreground image original onto a background image original.

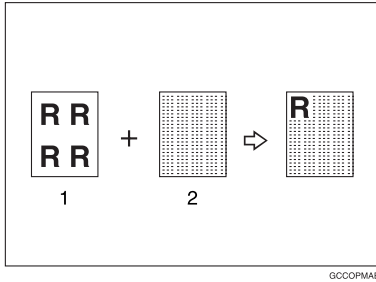

1. Foreground image original

2. Background image original

1 Place the foreground image original (original that has the image to be composed) on the right of the exposure glass. Then place the background image original (original that will be the background image) on the left of the exposure glass.

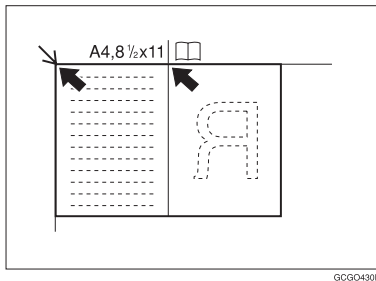

2 Press the [Image Overlay] key.

- 3** If the background original size is not A4, 8¹/₂" × 11", press the [Change] key, and then select the original size for the background.

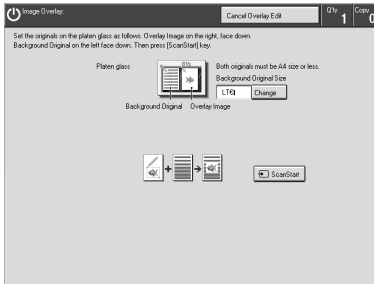

- 4** Press the [ScanStart] key.

- 5** Mark the first point with the editor pen.

- 6** Mark diagonally opposite corners of destination area.

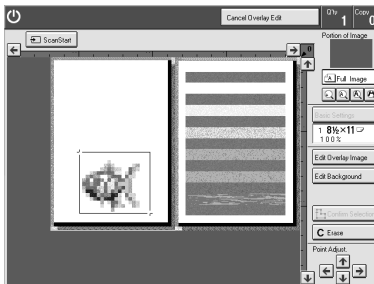

- 7** Press the [Confirm Selection] key.

- 8** If you want to edit the image, press the [Edit Overlay Image] key.

- 9** If you want to adjust the color/image adjustment, press the [Col./Image Adjust.] key.

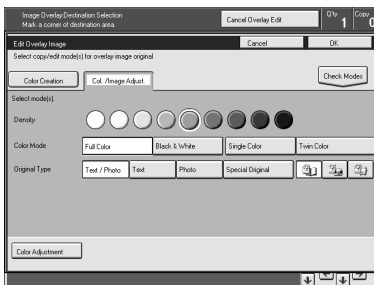

10 Make any adjustments you require.

Note

- Image Density, ⇒ P.28 “Adjusting Copy Image Density”.
- Color Mode, ⇒ P.30 “Selecting a Color Mode”.
- Original Type, ⇒ P.36 “Selecting the Original Image Type”.
- Image Adjustment, ⇒ P.142 “Image Adjustment”.
- Color Adjustment, ⇒ P.140 “Color Adjustment”.
- Color Balance Adjustment, ⇒ P.131 “Color Balance Adjustment”.

11 Press the [OK] key.

12 If you want to adjust the color creation, press the [Color Creation] key.

13 Make any adjustments you require.

Note

- Color Conversion, ⇒ P.94 “Color Conversion”.
- Color Erase, ⇒ P.96 “Color Erase”.
- Color Background, ⇒ P.97 “Color Background”.

14 Press the [OK] key.

15 Mark the first point on the background original with the editor pen.

16 Diagonally mark opposite corners of destination area on the background original.

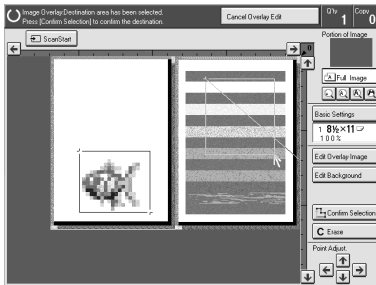

17 Press the [Confirm Selection] key.

Note

- If you want to edit the background original, press the [Edit Background] key. For details, ⇒ P.128 “Edit Background”.
- If you want to change the basic settings, press the [Basic Settings] key. For details, ⇒ P.130 “Basic Settings”.

18 Press the [Start] key.

Edit Background

You can edit the selected image.

Note

The modes that can be set are as follows:

- Color/Image Adjustment: Image Density, Color Mode, Original Type, Image Adjustment, Color Adjustment, Color Balance Adjustment
- Color Creation: Color Conversion, Color Erase, Color Background

Color/Image Adjustment

1 Press the [Edit Background] key.

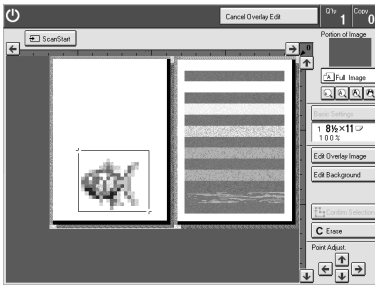

2 Press the [Col./Image Adjust.] key.

3 Make any adjustments you require.

Note

- Image Density, ⇒ P.28 “Adjusting Copy Image Density”.
- Color Mode, ⇒ P.30 “Selecting a Color Mode”.
- Original Type, ⇒ P.36 “Selecting the Original Image Type”.
- Image Adjustment, ⇒ P.142 “Image Adjustment”.
- Color Adjustment, ⇒ P.140 “Color Adjustment”.
- Color Balance Adjustment, ⇒ P.131 “Color Balance Adjustment”.

4 Press the [OK] key.

Color Creation

- 1** Press the [Edit Background] key.
- 2** Press the [Color Creation] key.
- 3** Make any adjustments you require.

 **Note**

- Color Conversion, ⇒ P.94 “Color Conversion”.
- Color Erase, ⇒ P.96 “Color Erase”.
- Color Background, ⇒ P.97 “Color Background”.

- 4** Press the [OK] key.

Basic Settings

You can change the job settings.

1 Press the [Basic Settings] key.

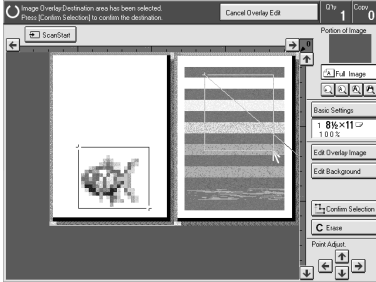

2 Make any adjustments you require.

Note

- Paper Select, ⇒ P.39 “Selecting the Copy Paper Size”.
- Preset R/E / Zoom, ⇒ P.58 “Reduce/Enlarge”.
- Margin Adjustment, ⇒ P.83 “Margin Adjustment”.

3 Press the [OK] key.

4. Adjustment and Color Memory

Color Balance

This function allows you to control the overall color tone of copies by adjusting the Yellow, Magenta, Cyan and Black color balance. Nine levels of tone are available.

Note

- The color balance will return to the default when:
 - The machine is automatically reset.
 - The **[Clear Modes]** key is pressed.
 - The operation switch is turned off.
 - The main power switch is turned off.
- You can store adjustments you make in memory and recall them later.

Color Balance Adjustment

- 1** Press the **[Adjustment/Memory]** key.

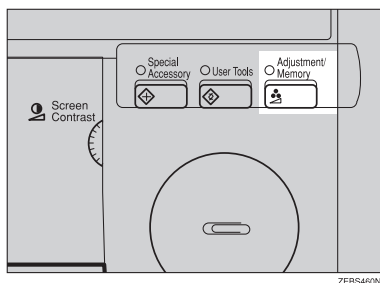

- 2** Make sure that the **[Color Balance Adj.]** key is selected.

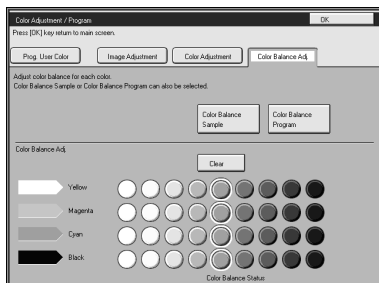

- 3** Adjust the color balance, and then press the **[OK]** key.

Color Balance Program

You can store the color balance setting in memory and recall it when you want to use it.

 **Note**

- You can store up to three color balances.

Storing the adjusted color balance

- 1** Change the color balance (⇒ P.131 “Color Balance Adjustment”), but do not press the [OK] key.
- 2** Press the [Color Balance Program] key.

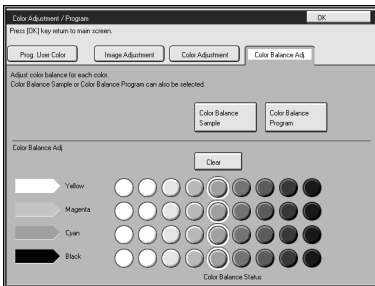

- 3** Press the [Program] key.
- 4** Select a number for this setting.

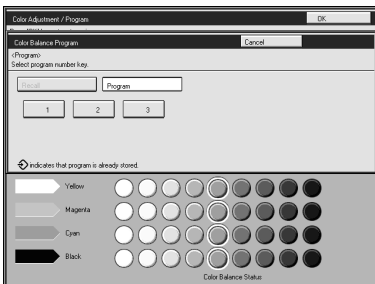

Recalling the color balance

- 1 Press the **[Adjustment/Memory]** key.

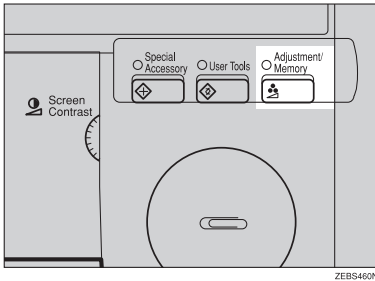

- 2 Make sure that the **[Color Balance Adj.]** key is selected.

- 3 Press the **[Color Balance Program]** key.

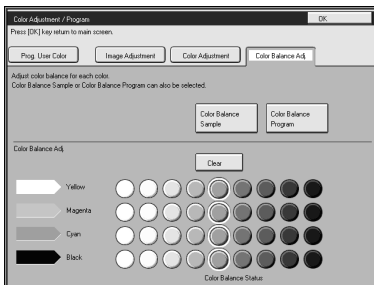

- 4 Make sure that the **[Recall]** key is selected.

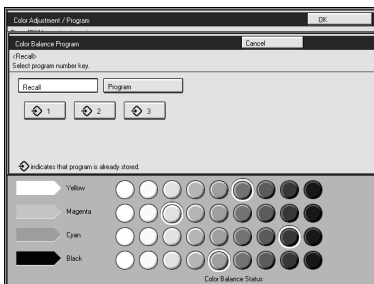

- 5 Select the setting you want to recall.





Note

- Only color balance programs with  contain a color balance.

Color Balance Sample

Adjusting the color balance by trial and error could require many copies. The color balance sampling function allows you to produce nine samples on two copies. The first sample of each sheet uses the current color balance (standard). Each sample after that changes one toner color by a fixed number of steps.

Note

- The sample will be copied on two A4 , 8¹/₂" × 11"  sheets or two A3 , 11" × 17"  sheets.
- Selecting Color Balance Sample does not reset the adjustments, allowing you to make many samples while progressively changing the balance. The sample might yield a color balance outside the copier's range which will be reproduced on the sample but not on the copy. For example, if yellow is already adjusted to +3 and you select Sample ±4, the yellow samples will be copied at yellow +7 and -1, but the adjustment for the final copy cannot be set to +7.
- The sampled area is as shown in the illustration.

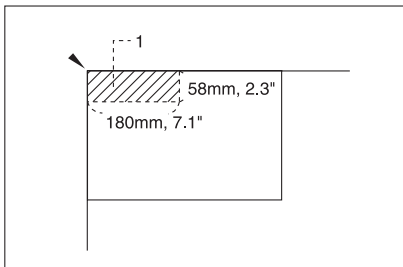

GCCLBA2E

1. Sampled area

1 Press the **[Adjustment/Memory]** key.

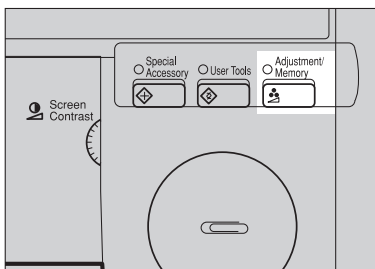

ZEB5460N

2 Make sure the **[Color Balance Adj.]** key is selected.

3 Press the [Color Balance Sample] key.

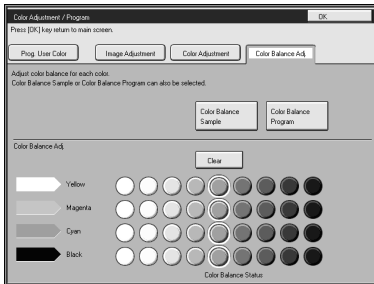

4 Select the range of densities (standard is the current setting).

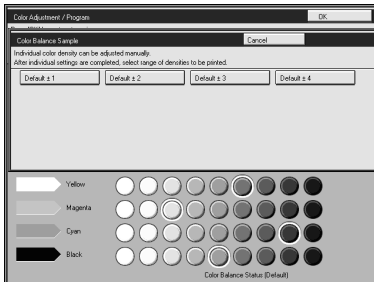

5 Place your original on the exposure glass.

6 Press the [Print Start] key.

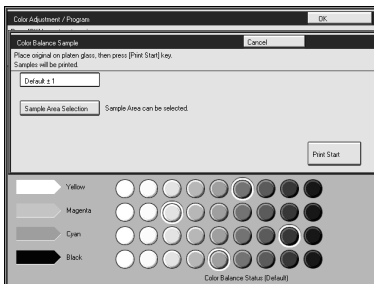

Note

- The sample is copied.

7 Select the color balance that you want to set, and then press the [OK] key.

Selecting the sampled area

Note

- The sampled area is as shown below.
 - a: 58mm, 2.3"
 - b: 180mm, 7.1"

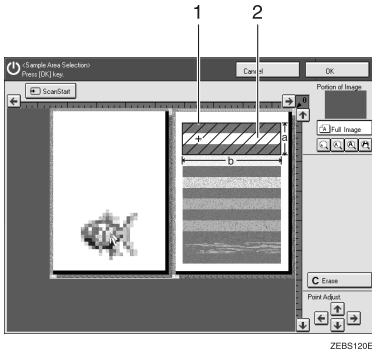

1. Selected position

2. Sampled area

- Orientation of the original and scanned image are related as shown:

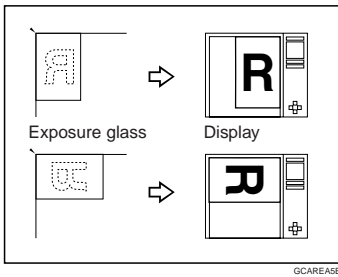

1 Press the **[Adjustment/Memory]** key.

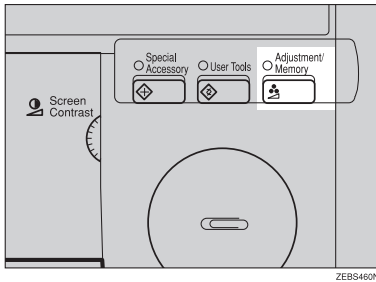

2 Make sure the **[Color Balance Adj.]** key is selected.

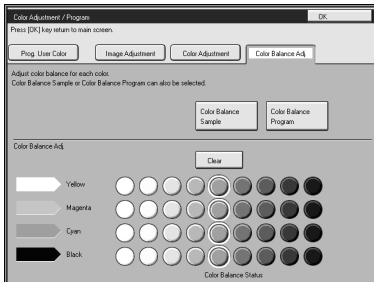

3 Press the **[Color Balance Sample]** key.

4 Select the range of densities (standard is the current setting).

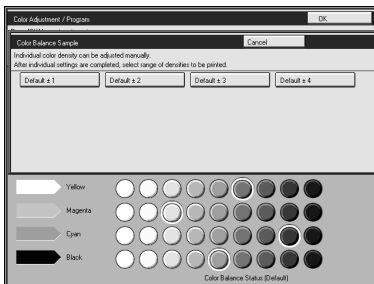

5 Place your original on the exposure glass.

6 Press the [Sample Area Selection] key.

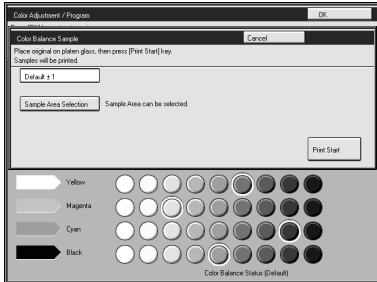

7 Press the [ScanStart] key.

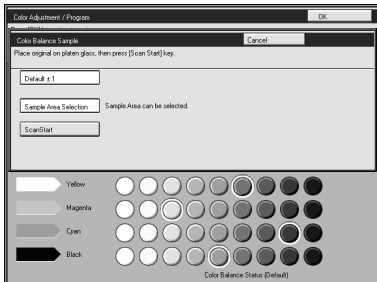

Note

- The image of the original is displayed.

8 Point at the center of the area with the editor pen or your finger, and then press the [OK] key.

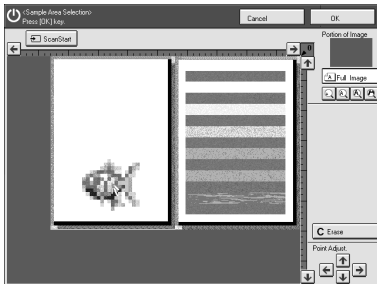

Note

- For details about this display, ⇒ P.154 "Designate Area Display".
- You can adjust the area with the Scroll key after you have pointed at the center of the area.

9 Press the [Print Start] key.

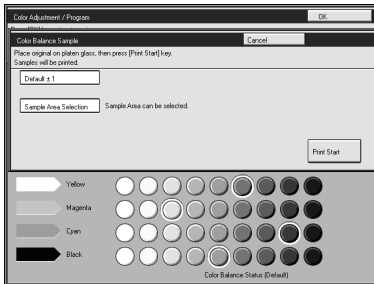

 **Note**

- The sample is copied.

10 Select the color balance that you want to set, and then press the [OK] key.

4

Color Adjustment

This function lets you alter up to three single colors by mixing them with adjacent colors in the color circle. For example, yellow can be shifted towards red to make orange, or towards green to make a yellow green. Note that only areas of the image containing this color will be modified.

Note

- This function is only available in Full Color mode or Auto Color Select mode.
- The single color adjustment will return to the default when:
 - The machine is automatically reset.
 - The **[Clear Modes]** key is pressed.
 - The operation switch is turned off.
 - The main power switch is turned off.

1 Press the **[Adjustment/Memory]** key.

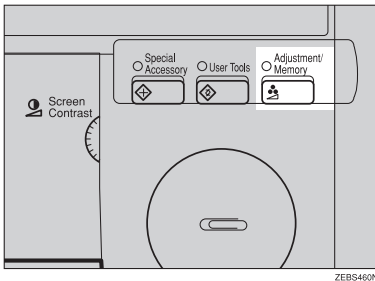

2 Press the **[Color Adjustment]** key.

3 Select the color key that you want to adjust from the color circle.

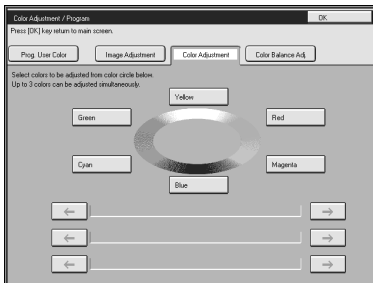

4 Adjust the color with the keys.

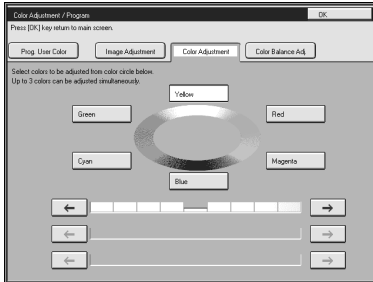







Note

- For example, if you wish to make yellow appear more red, press the [→] key.
- If you wish to make yellow appear more green, press the [←] key.

5 Press the [OK] key.

Image Adjustment

You can change the following default settings for image adjustment:

Soft/Sharp	<p>You can adjust the edges of the image to make the image sharper or softer.</p> <p> Note <input type="checkbox"/> Default: <i>level 4</i></p>
Contrast	<p>You can adjust the contrast between light parts and dark parts of the image.</p> <p> Note <input type="checkbox"/> Default: <i>level 5</i></p>
Background Density	<p>You can adjust the background density control.</p> <p> Note <input type="checkbox"/> Default: <i>level 5</i> <input type="checkbox"/> If copying a newspaper or an original with a dark background, adjust the background density to a lighter setting. <input type="checkbox"/> If part of the original is marked with a highlighting pen, adjust the background density to a darker setting. However, because the color of a highlighting pen is difficult to duplicate, it might be copied in different colors or some colors might not be copied.</p>
Pastel	<p>You can make copies in pastel tones.</p> <p> Note <input type="checkbox"/> Default: <i>level 9 which yields a normal color copy</i></p>
U.C.R. Adjustment	<p>You can adjust the black toner density to make the black parts clearer in Full Color mode.</p> <p> Note <input type="checkbox"/> Default: <i>level 5</i> <input type="checkbox"/> Adjust this setting to a darker setting when you want to copy letter parts clearly in black. <input type="checkbox"/> Adjust this setting to a lighter setting when the original image is dark.</p>
A.C.S. (Auto Color Selection) Sensitivity	<p>You can adjust the sensitivity when detecting whether the original has color areas in Auto Color Select mode. When set to "B&W" values, the machine will be more likely to detect originals as black originals. "Full Color" values will cause the machine to be more likely to detect originals as color originals.</p> <p> Note <input type="checkbox"/> Default: <i>level 3</i></p>
Text/Photo Sensitivity	<p>You can adjust the sensitivity when detecting letter and photo parts of an original in Text/Photo mode. If letter and photo parts of an original are not differentiated correctly, adjust this setting.</p> <p> Note <input type="checkbox"/> Default: <i>level 5</i></p>

Soft/Sharp, Contrast, Background Density, and Pastel

Note

- Any settings you make with the Soft/Sharp, Contrast, Background Density and Pastel functions will be canceled under the following conditions:
 - The machine is automatically reset.
 - The **[Clear Modes]** key is pressed.
 - The operation switch is turned off.
 - The main power switch is turned off.

1 Press the **[Adjustment/Memory]** key.

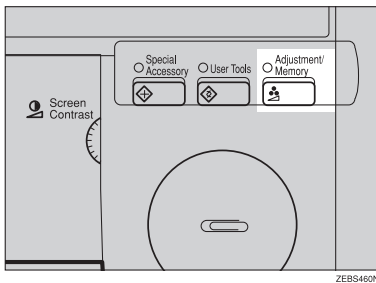

2 Press the **[Image Adjustment]** key.

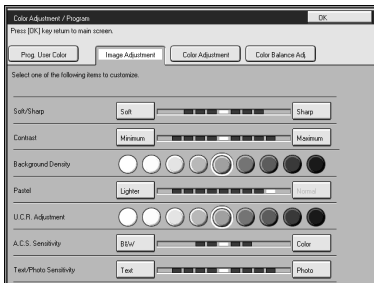

3 Adjust the settings.

Reference

For details, ⇒ P.142 "Image Adjustment".

4 Press the **[OK]** key.

Note

- If you do not press the **[OK]** key, you can still make copies, but the Image Adjustment settings you have just entered will not be used. However, any settings or features you choose before pressing the **[Adjustment/Memory]** key will still apply.

U.C.R. Adjustment, A.C.S. Sensitivity and Text/Photo Sensitivity

Note

- Any settings you make with the U.C.R. Adjustment, A.C.S. Sensitivity, and Text/Photo Sensitivity functions are not cleared by turning the power off or by pressing the **[Clear Modes]** key. They are canceled only when you overwrite them with new settings.

1 Press the **[Adjustment/Memory]** key.

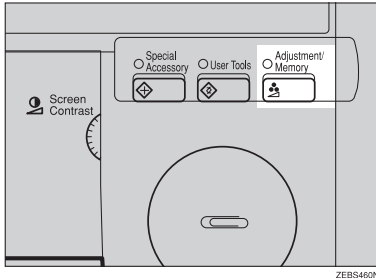

2 Press the **[Image Adjustment]** key.

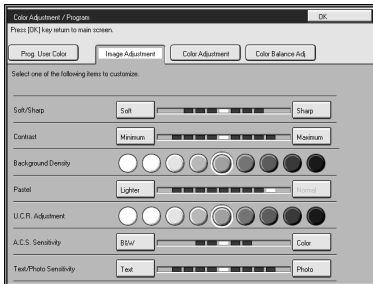

3 Adjust the settings.

Reference

For details, ⇒ P.142 "Image Adjustment".

4 Press the **[OK]** key.

Note

- If you do not press the **[OK]** key, you can still make copies, but the Image Adjustment settings you have just entered will not be used. However, any settings or features you choose before pressing the **[Adjustment/Memory]** key will still apply.

Program User Color

In addition to the base colors, you can store up to 15 customized colors into memory (User Color).

Reference

For color samples, ⇒ P.11 “Color Sample Chart”.

Note

- There are two ways to make user colors as follows:
 - Adjusting a selected base color
 - Mixing colors manually with number keys
- Up to 15 colors can be stored.
- The total percentages of the mixed colors must be 255% or less.
- If the total percentage of the mixed color is over 255%, the copier cannot create the color properly and the results will appear different.
- If the total percentage of the mixed colors is too low, it may not be bonded to the paper properly resulting in a change in image density.
- The appearance of user colors might vary slightly according to the image type you have selected (ex. Photo, Text, etc.).

4

Adjusting Colors Based on the Selected Color

1 Press the **[Adjustment/Memory]** key.

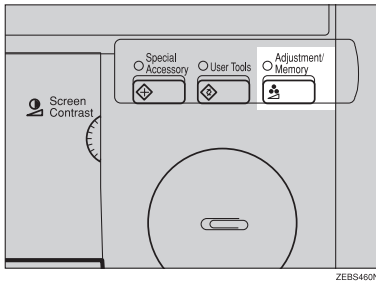

2 Press the **[Prog. User Color]** key.

3 Select the key you wish to store the color in.

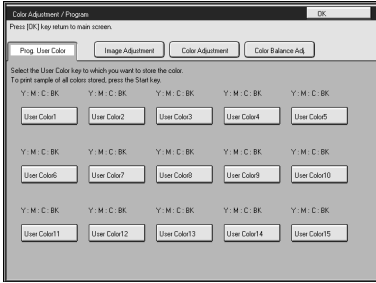

4 Select the base color.

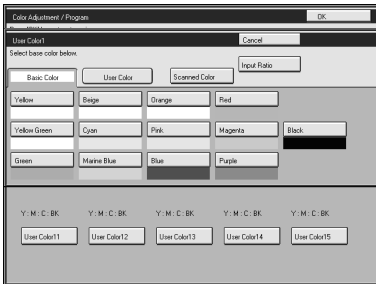

5 You can change the color density in two ways. Press the [+ - keys] key.

Note

- Adjust the color density with the [+] or [-] key.

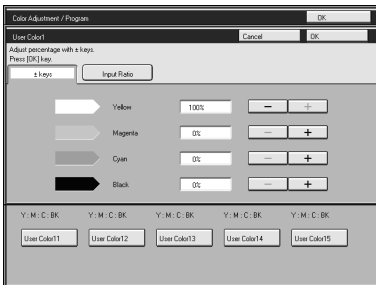

- Enter the percentage with the number keys. Press the **[Input Ratio]** key.

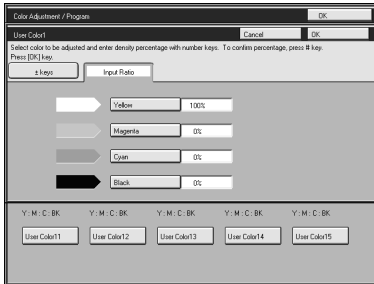

- 6** Repeat step **5** for each color, then press the **[OK]** key.

- 7** Press the **[OK]** key.

4

Mixing Colors Manually with the Number Keys

- 1** Press the **[Adjustment/Memory]** key.

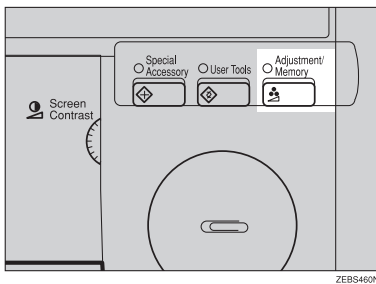

ZEBS460N

- 2** Press the **[Prog. User Color]** key.

- 3** Select the number that you want to store the user color in.

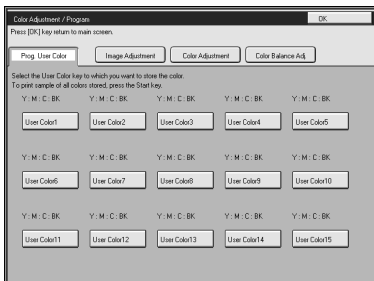

4 Press the [Input Ratio] key.

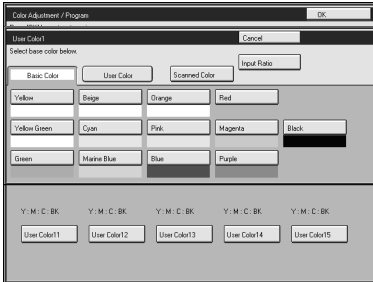

5 Select the color that you want to adjust.

6 Enter the density with the number keys, and then press the [#] key.

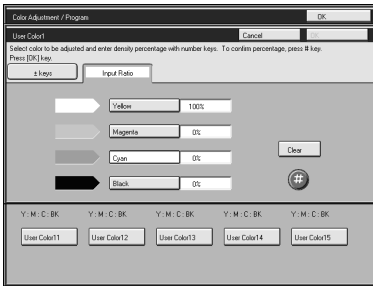

Note

□ To change the number, press the [Clear] key.





7 Repeat steps 5 and 6 for each color, and then press the [OK] key.

8 Press the [OK] key.

Sampling the User Colors

You can print out a sample of User Colors to check the colors you have made.

Note

- The sample will be copied on a A4 , 8¹/₂" × 11"  sheet or a A3 , 11" × 17"  sheet.

1 Press the **[Adjustment/Memory]** key.

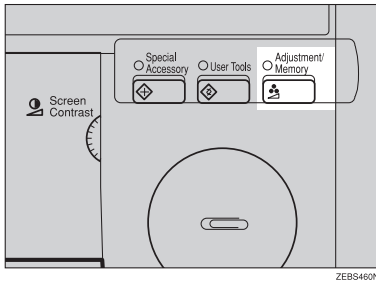

2 Press the **[Prog. User Color]** key.

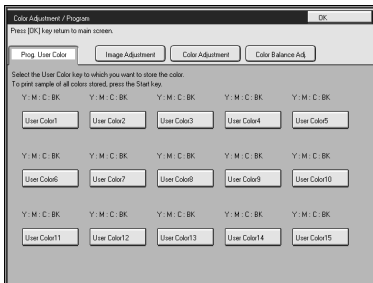

3 Press the **[Start]** key.

4

5. Area Editing (Option)

What is Area Editing?

If your machine has the optional editing kit, you can select areas of an image to be treated differently or have effects applied to them. Some examples are shown below.

Example:

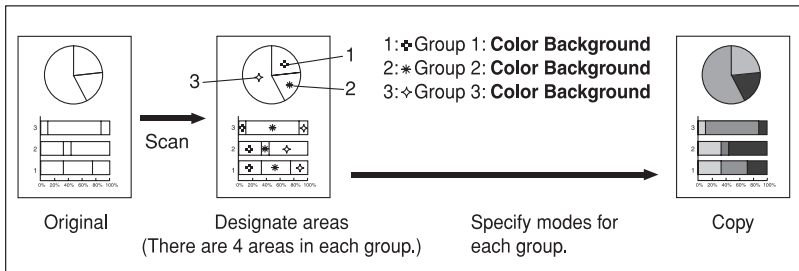
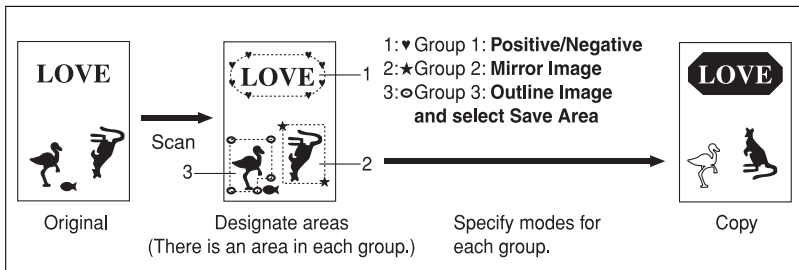

Note

□ In this chapter, multiple areas of the image that you wish to apply the same effects to are referred to as a "Group".

How to Edit Areas

Editing an image involves scanning it in to memory, choosing areas to edit and how those areas will be re-produced.

The basic steps are summarized below. Details are given in the rest of this section.

- ① Enter Area Editing mode.
Press the **[Area Editing]** key.
- ② Designate areas.
⇒ P.153 "*Designating Areas*".
- ③ Select modes.
⇒ P.165 "*Selecting Modes for Designated Areas*".
- ④ Specify more areas to be treated differently (optional).
Repeat ③ and ④.
- ⑤ Copy image.
Press the **[Start]** key.

5

Designating Areas

Several tools are provided for designating areas of an image.

Area Shapes

- **Rectangle:** Specify two points defining the opposite diagonals of a rectangle.
- **Right Angle Polygon/Polygon:** Specify a sequence of points defining a polygon.
- **Closed Loop:** If your image contains a shape outlined in black and that outline forms a closed loop, specify a point inside the shape to designate it.
- **Multi-Closed Loop:** If your image contains a closed loop and that outline forms an another closed loop, specify points inside of the closed loop to designate it.

Frame/Line

- **Rectangle frame:** Specify areas defined by a rectangular frame.
- **Right Angle Polygon/Polygon frame:** Specify areas defined by a polygon or right-angled polygon.
- **Line:** Specify a series of points linked together by straight lines.

Note

- You can designate many areas and apply the same changes to them all by placing them in the same Group.
- Different areas may be treated differently by placing them in different Groups.

Designate Area Display

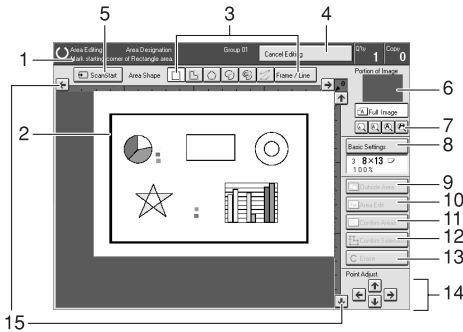

ZEBSS30N

1. Message Area

Messages and instructions appear here.

2. Display Area

The image is displayed.

3. Area Shape/Frame/Line

Select the area shape or frame shape and line.

4. Cancel Editing

Exit area editing.

5. Scan Start

Scan in an original again.

6. Portion of Image

Shows the portion of the original that is currently being viewed or is enlarged.

7. Enlarge

Enlarge 4

Enlarge by about 528%

Enlarge 3

Enlarge by about 394%

Enlarge 2

Enlarge by about 264%

Enlarge 1

Enlarge by about 200%

Full Image

Note

- After pressing the [Enlarge] key, mark a point in the displayed image to zoom in on.

8. Basic Settings

Change the job settings for the entire image.

9. Outside Area

Set modes for outside areas.

10. Area Edit

Edit inside the area.

11. Confirm Areas

Show selected areas, modes, and groups.

12. Confirm Selection

Complete a designated area.

13. Erase

Cancel last point selected.

14. Arrow keys

Move cursor in small steps.

15. Scroll key

Move the portion of the original.

Note

- Do not press the touch panel display with any hard or sharp object. Always use the editor pen.
- When you mark a point with the editor pen, the cursor position might not be quite right. In this case, move the cursor in small steps by pressing the arrow keys on the display.

Designate Area Tools

Note

- There are nine tools to designate areas.

Area Editing	Area Shape	Rectangle (⇒ P.156 “Rectangle”.)
		Right Angle Polygon (⇒ P.157 “Right Angle Polygon and Polygon”.)
		Polygon (⇒ P.157 “Right Angle Polygon and Polygon”.)
		Closed Loop (⇒ P.158 “Closed Loop”.)
		Multi-Closed Loop (⇒ P.158 “Multi-Closed Loop”.)
	Frame/Line	Rectangle frame (⇒ P.160 “Rectangle frame”.)
		Right Angle Polygon frame (⇒ P.160 “Right Angle Polygon frame and Polygon frame”.)
		Polygon frame (⇒ P.160 “Right Angle Polygon frame and Polygon frame”.)
		Line (⇒ P.161 “Line”.)

Note

- You cannot use the optional document feeder with this function.
- The relationships between the position of the original and the orientation of the scanned image on the display are as follows:

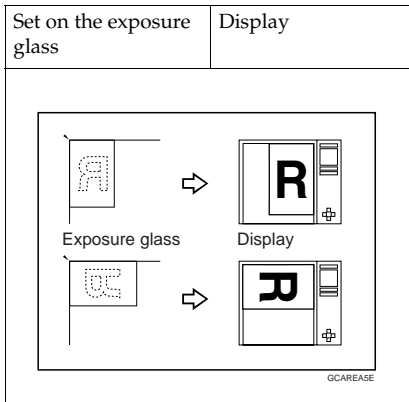

Area Shapes

Rectangle

- 1** Place your original on the exposure glass.
- 2** Press the **[Area Editing]** key.

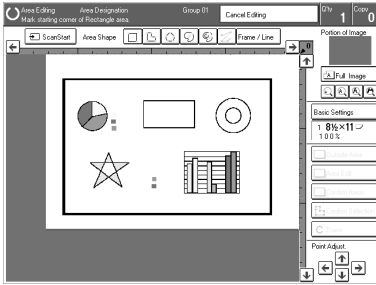

Note

- [Rectangle]** key is selected by default.

- 3** Mark the first point with the editor pen.
- 4** Diagonally mark opposite corner of the area you wish to select.

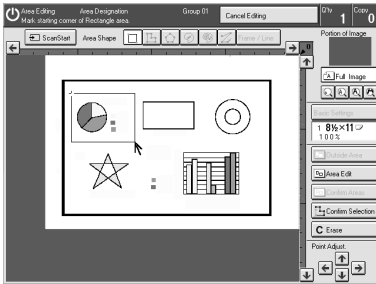

Note

- When you make a mistake, press the **[Erase]** key.
- Repeat **4** and **5** to add more rectangles.
- When you continue to add areas, you can select other shapes (except Closed Loop, Multi-Closed Loop, Line, Frame).

- 5** Press the **[Confirm Selection]** key.



- 6** Press the [Area Edit] key, and specify your settings, and then press the [OK] key.

 **Reference**

For details, ⇒ P.165 “Selecting Modes for Designated Areas”.

- 7** Press the [Start] key.

Right Angle Polygon and Polygon

- 1** Place your original on the exposure glass.
- 2** Press the [Area Editing] key.
- 3** Press the  [R.A. Polygon] or  [Polygon] key.
- 4** Mark the first point with the editor pen.
- 5** Mark the next points.

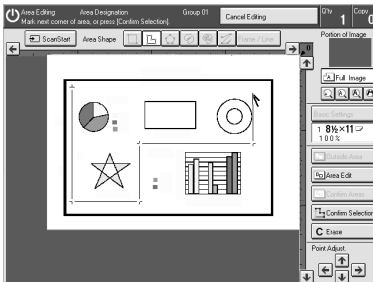

 **Note**

- When you use Right Angle Polygon mode, mark points that make right angles.

- 6** After making the last point, press the [Confirm Selection] key.
- 7** Press the [Area Edit] key, specify your settings, and then press the [OK] key.

 **Reference**

For details, ⇒ P.165 “Selecting Modes for Designated Areas”.

- 8** Press the [Start] key.

Closed Loop

Limitation

- If you specify an area with Closed Loop, you cannot specify any additional areas with other selection tools.

Note

- When you color areas with the Closed Loop, the area boundary may shift depending on the image.

1 Place your original on the exposure glass.

2 Press the [Area Editing] key.

3 Press the  [Closed Loop] key.

4 Touch on a point inside a closed loop.

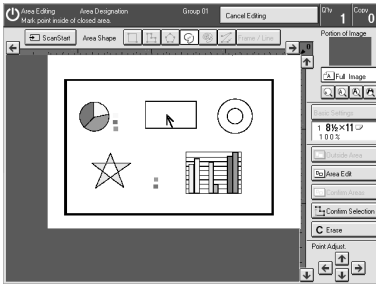

5 Press the [Confirm Selection] key.

6 Press the [Area Edit] key, specify your settings, and then press the [OK] key.

Reference

For details, ⇒ P.165 “Selecting Modes for Designated Areas”.

7 Press the [Start] key.

Multi-Closed Loop

Limitation

- If you specify an area with Multi-Closed Loop, you cannot specify any additional areas with other selection tools.

1 Place your original on the exposure glass.

2 Press the [Area Editing] key.

3 Press the  [Multi-Closed Loop] key.

4 Press on a point inside the exterior area you wish to specify.

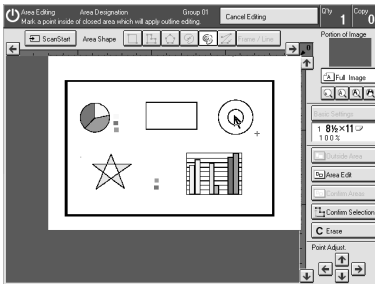

5 Press on a point inside the interior area you wish to treat differently.

 **Note**

- Be sure to select a point inside of the exterior area you wish to define.

6 Press the [Confirm Selection] key.

7 Press the [Area Edit] key, specify your settings, and then press the [OK] key.

 **Reference**

For details, ⇒ P.165 "Selecting Modes for Designated Areas".

8 Press the [Start] key.

5

Frame/Line

Rectangle frame

- 1 Place your original on the exposure glass.
- 2 Press the [Area Editing] key.
- 3 Press the [Frame / Line] key.
- 4 Press the  [Rectangle] key.

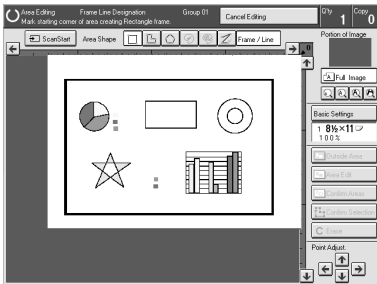

- 5 Mark the first point with the editor pen.
- 6 Diagonally mark opposite corner of the area you wish to select.
- 7 Press the [Confirm Selection] key.
- 8 Press the [Area Edit] key, specify your settings, and then press the [OK] key.

 **Reference**

For details, ⇒ P.165 "Selecting Modes for Designated Areas".

- 9 Press the [Start] key.

Right Angle Polygon frame and Polygon frame

- 1 Place your original on the exposure glass.
- 2 Press the [Area Editing] key.
- 3 Press the [Frame / Line] key.

- 4** Press the  [Right Angle Polygon] key or the  [Polygon] key.

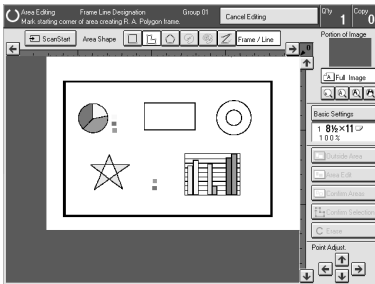

- 5** Mark the first point with the editor pen.
- 6** Mark the next points.
- 7** After making the last point, press the [Confirm Selection] key.
- 8** Press the [Area Edit] key, specify your settings, and then press the [OK] key.



Reference

For details, ⇒ P.165 “Selecting Modes for Designated Areas”.

- 9** Press the [Start] key.

Line

- 1** Place your original on the exposure glass.
- 2** Press the [Area Editing] key.
- 3** Press the [Frame / Line] key.
- 4** Press the  [Line] key.

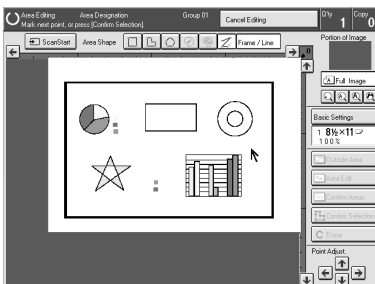

- 5** Mark the first point with the editor pen.

6 Mark the next points.

7 After marking the last point, press the [Confirm Selection] key.

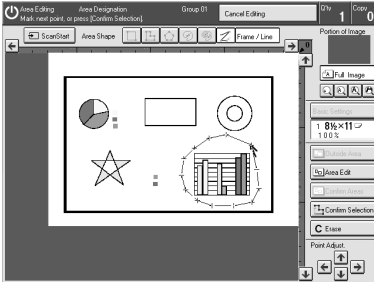

8 Press the [Area Edit] key, specify your settings, and then press the [OK] key.

5  **Reference**

For details, ⇒ P.165 "Selecting Modes for Designated Areas".



9 Press the [Start] key.

Notes for Designating Areas

The number of the points, areas, and groups that can be designated

Note

- Maximum number of points: 500
- In Right Angle Polygon mode, Polygon mode, or Line mode, the maximum number of points for one area is 30.
- The number of areas that can be designated is as follows:
 - Rectangle mode: maximum 250 areas
 - Right Angle Polygon mode, Polygon mode, Line mode: 500 points maximum. For example, if 10 points are designated for each area, the maximum number of areas that can be designated is 50.
 - Closed Loop mode, Multi-Closed Loop mode: maximum 500 areas
- Maximum number of groups: 20 (multiple areas of the image that you wish to apply the same effects to are referred to as a "Group")
- If you want to designate area shape like an acute angle by using Polygon mode or Line mode, see the following instructions.
 - Use two separate lines to create angle(A).
 - The first designated point(1) and the next designate point(3) should have distance of more than 4mm(0.2")(B).

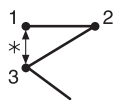
	Area you want to designate	How to designate area
A		
B		

GCAREAME

*:4mm(0.2")

Note

- Do not designate an area or line which overlaps part of another area or line. If an area overlaps another one, the job settings specified last will be applied to the overlapped portion. As a result, those areas might not be copied.

- However, areas containing areas (see below) are permitted. Designate starting with the outermost area.

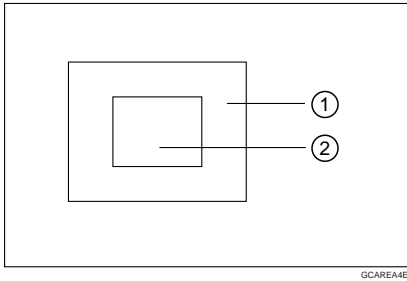

- These operations are available, under the following conditions:
 - When designating areas with Closed Loop mode, Multi-closed Loop or Line/Frame mode.
- If you mark a line and it overlaps another line you have previously marked, the last point you marked will be canceled automatically.
- If you designate an area in Right Angle Polygon mode, make sure to mark points that make right angles. If you mark a point which does not match, the editor will automatically correct it to make a right angle.
- If you want to designate a triangular area, use Polygon mode.
- In Closed Loop mode or Multi-Closed Loop mode, the machine might not detect a closed loop area or multi-closed loop area completely under the following conditions:
 - The outline is not completely closed, it is too light to detect, or the thickness is uneven.
 - The outline is thinner than 0.3mm.
 - The outline is not black.
 - The space between two closed loop outlines is less than 1mm.
 - The closed loop can be up to 2 meters long.
 - The area enclosed by the outline is not white.
- The more areas you designate, the more time copying will take.
- If you erase an area, group, or job setting, it is cleared from the display. However, the points are still stored in memory and are not cleared until you exit Area Editing. This affects the maximum number of areas you can designate.
- Closed Loop mode, Multi-Closed Loop mode and Frame/Line mode cannot be used with Rectangle mode, Right Angle Polygon mode, and Polygon mode for one group at a time.
- If you need to align areas precisely, you can have a grid shown on the enlarged display. The grid spacing matches the scale of the display.

5

Selecting Modes for Designated Areas

Reference

The available modes for area editing depend on the area shape. ⇒ P.182 “*Combination Chart for Area Editing*”.

For functions that cannot be used together in area editing, ⇒ P.182 “*Combination Chart for Area Editing*”.

More than one mode can be set for a designated area, however, there are some limitations, ⇒ P.182 “*Combination Chart for Area Editing*”. And up to 7 patterns of modes can be set together.

Note

- ❑ Up to 20 groups of multiple areas can be edited. All the areas should belong to groups 1 - 20. You can select up to seven job patterns for at most 20 groups. After you have set seven patterns, the copier will only allow you to choose the pattern of a previous group. If you change the settings for one group, it will change the settings for all other groups with the same job pattern. However, if you have set a Paint, Color Background, or Frame/ Line, changing the color in one group will not affect other groups. (Up to 15 colors can be selected.)
- ❑ The modes that can be set for inside areas are as follows:
 - Color/Image Adjustment: Image Density, Color Mode, Original Type, Image Adjustment, Color Adjustment, Color Balance Adjustment
 - Color Creation: Color Conversion, Color Erase, Color Background, Paint, Type Mask
 - Image Creation: Outline Image, Shadow Image, Slanted Image, Mirror Image, Positive/Negative

Note

- ❑ The editing functions are available when specifying area with Frame/Line mode are Width and Color.
- ❑ Color/Image Adjustment's default setting:
 - Image Density - Manual Image Density
 - Color Mode - Black
 - Original Type - Text
- ❑ You can change the default settings. ⇒ P.211 “*User Tools*”.
- ❑ Depending on the shapes of the areas, coloring or deleting near the outlines of the areas might not do well, or the outlines might become uneven.

- The way to set modes is basically the same as for the entire image. For details, refer to each page.
- To fill an area with a selected color, select the Paint.
 - Image Density (⇒ P.28 “*Adjusting Copy Image Density*”.)
 - Original Type (⇒ P.36 “*Selecting the Original Image Type*”.)
 - Color Adjustment (⇒ P.140 “*Color Adjustment*”.)
 - Color Conversion (⇒ P.94 “*Color Conversion*”.)
 - Type Mask (⇒ P.99 “*Type Mask*”.)
 - Color Background (⇒ P.97 “*Color Background*”.)
 - Outline Image (⇒ P.101 “*Outline Image*”.)
 - Slanted Image (⇒ P.106 “*Slanted Image*”.)
 - Positive/Negative (⇒ P.114 “*Positive/Negative*”.)
 - Color Mode (⇒ P.30 “*Selecting a Color Mode*”.)
 - Image Adjustment (⇒ P.142 “*Image Adjustment*”.)
 - Color Balance Adjustment (⇒ P.131 “*Color Balance Adjustment*”.)
 - Color Erase (⇒ P.96 “*Color Erase*”.)
 - Shadow Image (⇒ P.102 “*Shadow Image*”.)
 - Mirror Image (⇒ P.108 “*Mirror Image*”.)
 - Save Area (⇒ P.169 “*Save Area*”.)
 - Changing Basic Settings for the Entire Image (⇒ P.174 “*Changing Basic Settings for the Entire Image*”.)
 - Change Modes (⇒ P.176 “*Change Modes*”.)
 - Adding Areas (⇒ P.178 “*Adding Areas*”.)
 - Erasing a Group (⇒ P.180 “*Erasing a Group*”.)

5

Area Editing

Basic modes

1 Designate the areas you wish to modify.

 **Note**

- For details about how to designate areas, ⇒ P.153 “Designating Areas”.

2 Press the [Area Edit] key.

3 Press the [Col./Image Adjust.], [Color Creation] or [Image Creation] key.

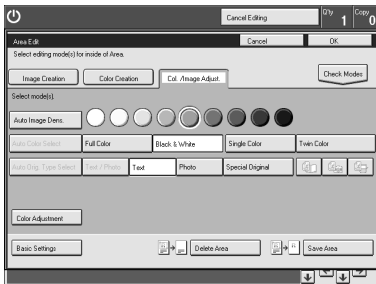

4 Set the effects you wish to apply.

 **Note**

- Color/Image Adjustment, ⇒ P.128 “Color/Image Adjustment”.
- Color Creation, ⇒ P.94 “Color Creation”.
- Image Creation, ⇒ P.101 “Image Creation”.

5 Press the [OK] key.

6 Press the [Start] key.

Delete Area

This function blanks out designated areas.

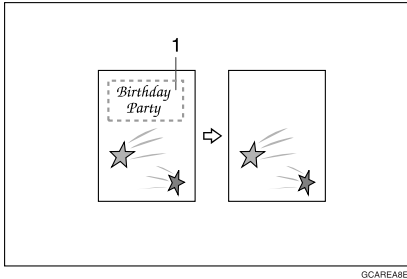

GCAREABE

1. Designated area

Note

- When you select Delete Area mode, previously selected modes are canceled.

1 Designate the areas you wish to modify.

2 Press the [Area Edit] key.

Note

- For details about how to designate areas, ⇒ P.153 “Designating Areas”.

3 Press the [Delete Area] key.

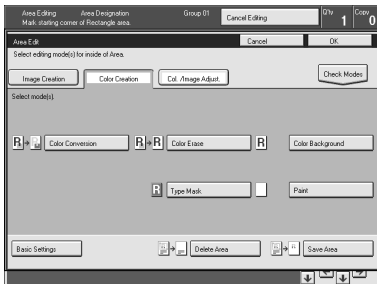

4 Press the [OK] key.

5 Press the [Start] key.

Save Area

This function blanks out all areas except those designated.

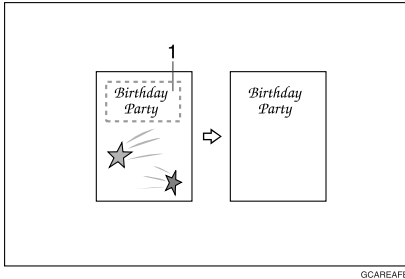

GCAREAFE

1. Designated area

Note

- When you select Save Area mode, previously selected modes are canceled.

1 Designate the areas you wish to modify.

Note

- For details about how to designate areas, ⇒ P.153 “Designating Areas”.

2 Press the [Area Edit] key.

3 Press the [Save Area] key.

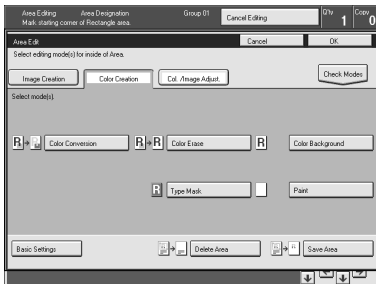

4 Press the [OK] key.

5 Press the [Start] key.

Frame/Line

Editing color and widths

Note

- When specifying the Area for the Frame/Line mode, only the line color and width are features that can be selected.
- Frame/Line widths:
 - Metric version: 0.25 - 2.0mm (in 0.25mm steps)
 - Inch version: 0.01" - 0.08" (in 0.01" steps)
- The frame and line width might be uneven depending on the angle of the line.

1 Designate the areas you wish to modify.

Note

- For details about how to designate areas, ⇒ P.153 “Designating Areas”.

2 Press the [Area Edit] key.

3 Select the color and widths.

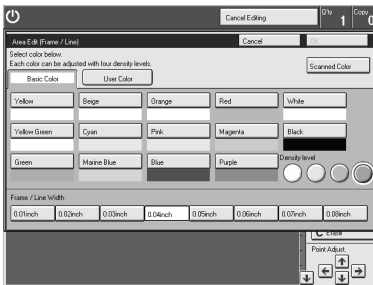

4 Press the [OK] key.

Selecting Modes for Outside Designated Areas

Reference

The available modes for area editing depend on the area shape. ⇒ P.182 *“Combination Chart for Area Editing”*.

For functions that cannot be used together in area editing, ⇒ P.182 *“Combination Chart for Area Editing”*.

More than one mode can be set. However, there are some limitations, ⇒ P.182 *“Combination Chart for Area Editing”*.

The modes that can be set for outside areas are as follows:

- Color/Image Adjustment: Image Density, Color Mode, Original Type, Image Adjustment, Color Adjustment, Color Balance Adjustment
- Color Creation: Color Conversion, Color Erase, Color Background, Paint, Type Mask
- Image Creation: Outline Image, Shadow Image, Positive/Negative

Note

Color/Image Adjustment's default setting:

- Image Density - Manual Image Density
- Color Mode - Black
- Original Type - Text/Photo

You can change the default settings. ⇒ P.211 *“User Tools”*.

The way to set modes is basically the same as for the entire image. For details, refer to each page.

- To fill an area with a selected color, select the Paint.
- Image Density (⇒ P.28 *“Adjusting Copy Image Density”*.)
- Original Type (⇒ P.36 *“Selecting the Original Image Type”*.)
- Color Adjustment (⇒ P.140 *“Color Adjustment”*.)
- Color Conversion (⇒ P.94 *“Color Conversion”*.)
- Color Background (⇒ P.97 *“Color Background”*.)
- Type Mask (⇒ P.99 *“Type Mask”*.)
- Outline Image (⇒ P.101 *“Outline Image”*.)
- Positive/Negative (⇒ P.114 *“Positive/Negative”*.)
- Color Mode (⇒ P.30 *“Selecting a Color Mode”*.)
- Image Adjustment (⇒ P.142 *“Image Adjustment”*.)
- Color Balance Adjustment (⇒ P.131 *“Color Balance Adjustment”*.)
- Color Erase (⇒ P.96 *“Color Erase”*.)
- Shadow Image (⇒ P.102 *“Shadow Image”*.)
- Save Area (⇒ P.169 *“Save Area”*.)

Area Shapes

Basic modes

1 Designate the areas you wish to modify.

 **Note**

- For details about how to designate areas, ⇒ P.153 “Designating Areas”.

2 Press the [Outside Area] key.

3 Press the [Col./Image Adjust.], [Color Creation] or [Image Creation] key.

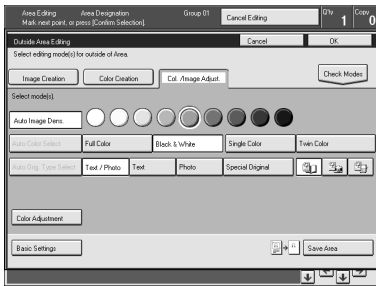

4 Set the effects you wish to apply.

 **Note**

- Color/Image Adjustment, ⇒ P.128 “Color/Image Adjustment”.
- Color Creation, ⇒ P.94 “Color Creation”.
- Image Creation, ⇒ P.101 “Image Creation”.
- Basic Settings, ⇒ P.174 “Changing Basic Settings for the Entire Image”.

5 Press the [OK] key.

6 Press the [Start] key.

Save Area

1 Designate the areas you wish to modify.

 **Note**

For details about how to designate areas, ⇒ P.153 “Designating Areas”.

2 Press the [Area Edit] or [Outside Area] key.

3 Press the [Save Area] key.

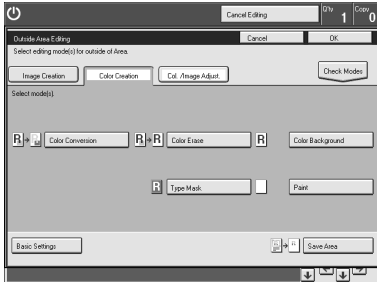

4 Select the effects you wish to apply, and then press the [OK] key.

5 Press the [Start] key.

Changing Basic Settings for the Entire Image

You can change job settings for the entire image during area editing.

The job settings that can be changed are as follows:

- Paper Select, ⇒ P.39 “*Selecting the Copy Paper Size*”.
- Auto Reduce/Enlarge, ⇒ P.51 “*Auto Reduce/Enlarge*”.
- Reduce/Enlarge (Preset R/E, Zoom, Size Magnification, Directional Magnification, Poster Mode), ⇒ P.58 “*Reduce/Enlarge*”.
- Shift, ⇒ P.82 “*Shift*”.
- Margin Adjustment, ⇒ P.83 “*Margin Adjustment*”.
- Sort/Stack/Staple (Option), ⇒ P.116 “*Finishing*”.

Note

- For functions that cannot be used together in area editing, ⇒ P.182 “*Combination Chart for Area Editing*”.
- When you set Shift and Save Area together and designate more than one area in this mode, the minimum size rectangle that includes all the designated areas is shifted as follows:
-

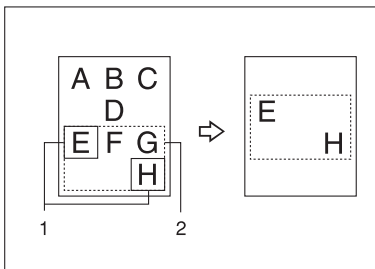

1. Designated area
2. Area that will be shifted

1 Press the [Basic Settings] key.

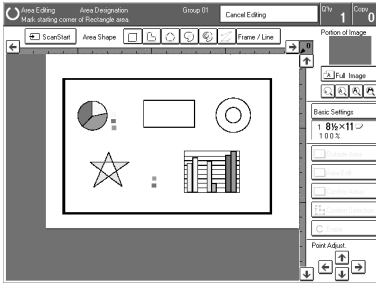

2 Change the job settings.

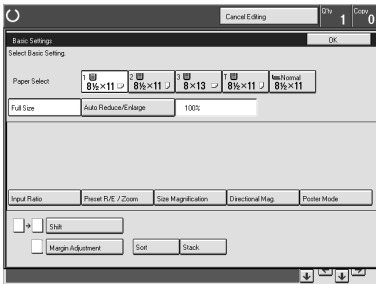

3 Press the [OK] key.

5

Checking and Changing Areas

Use this function to check the areas you have selected and the modes you have chosen for each area.

You can:

- Change the modes for an area/group
- Add an area to a group
- Erase an area
- Erase a group

Note

- Note that even if you erase a job setting, a group, or an area, they still consume memory until you exit Area Editing.

5 Change Modes

1 Press the [Confirm Areas] key.

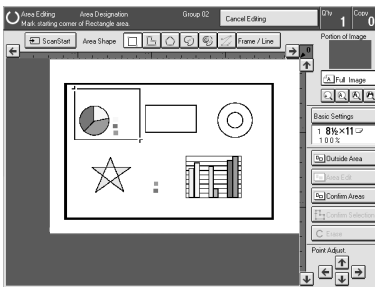

Note

- All designated areas are displayed.

2 Select an area or a group.

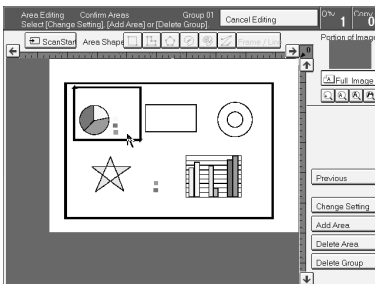

Note

- Areas in this group are highlighted.

3 Press the [Change Setting] key.

4 Change the modes, and then press the [OK] key.

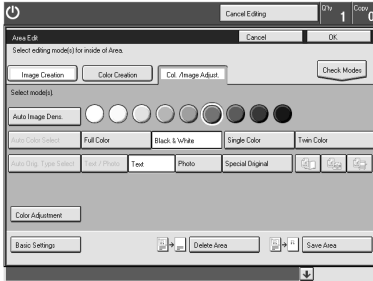

 **Note**

- Color/Image Adjustment, ⇒ P.128 “Color/Image Adjustment”.
- Color Creation, ⇒ P.94 “Color Creation”.
- Image Creation, ⇒ P.101 “Image Creation”.
- Color Adjustment, ⇒ P.140 “Color Adjustment”.
- Basic Settings, ⇒ P.174 “Changing Basic Settings for the Entire Image”.
- Delete Area, ⇒ P.168 “Delete Area”.
- Save Area, ⇒ P.169 “Save Area”.

5 Press the [Previous] key.

Adding Areas

1 Press the [Confirm Areas] key.

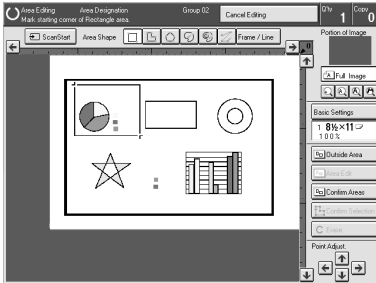

Note

- All designated areas are displayed.

2 Select an area or a group.

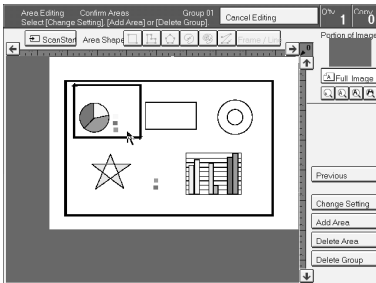

Note

- Areas in this group are highlighted.

3 Press the [Add Area] key.

4 Select the area shape.

5 Designate areas, and then press the [Confirm Areas] key.

Note

- For details about how to designate areas, ⇒ P.153 “Designating Areas”.

6 Press the [Previous] key.

Erasing an Area

1 Press the [Confirm Areas] key.

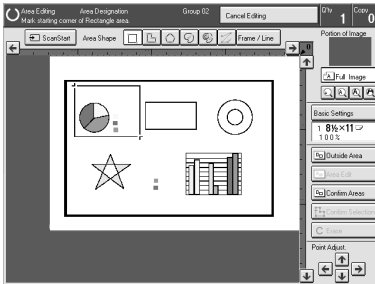

 **Note**

All designated areas are displayed.

2 Select an area that you want to cancel.

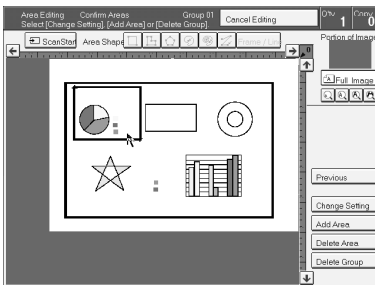

3 Press the [Delete Area] key.

4 Press the [Yes] key.

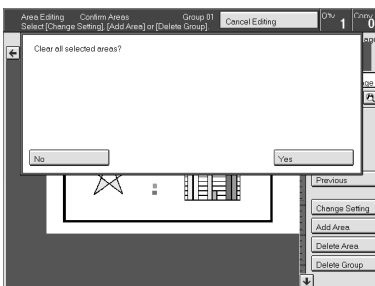

5 Press the [Previous] key.

Erasing a Group

1 Press the [Confirm Areas] key.

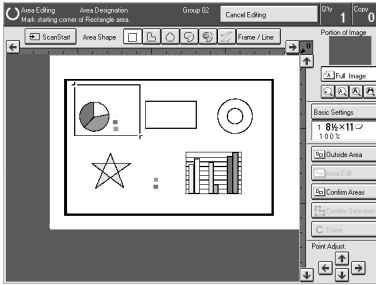

 **Note**

- All designated areas are displayed.

2 Select a group that you want to cancel.

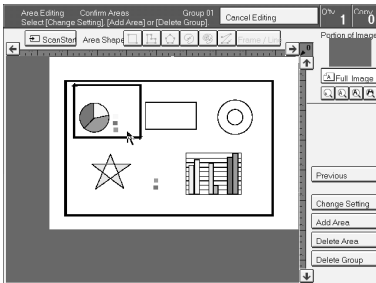

 **Note**

- Areas in this group are highlighted.

3 Press the [Delete Group] key.

4 Press the [Yes] key.

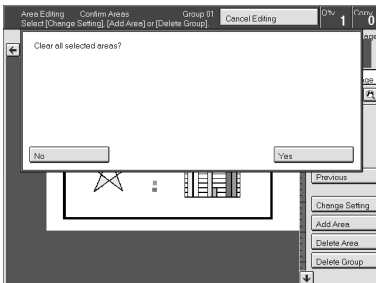

5 Press the [Previous] key.

Exiting Area Editing

1 Press the [Cancel Editing] key.

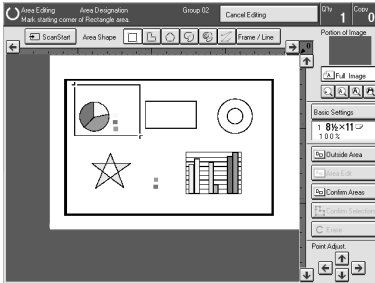

2 Press the [Yes] key.

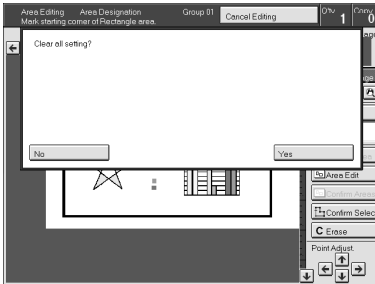

5

Combination Chart for Area Editing

- ① Functions available for designated areas.
- ② Functions available for areas outside designated areas.
- ③ Functions that can be selected together in an area.
- ④ Functions available with each shape.
- ⑤ Functions available for the entire image.
- ☆: Those modes can be used together.
- ★: Those modes can be used together with some limitations.
- : The original mode is overridden and only the newly selected mode is active.
- X: These modes cannot be used together.

5

		①	②	③ Newly selected mode																							
				Den- sity						Color Mode						Color Creation						Image Creation					
				Auto Image Density	Manual Image Density	Full Color	Black & White	Single Color	Twin Color	Original Image Type Selection	Type Mask	Color Conversion	Color Erase	Color Background	Paint	Outline Image	Shadow Image	Slanted Image	Mirror Image	Positive/Negative							
Image Density	Auto Image Density	★	☆	-	☆	→	☆	☆	☆	☆	☆	☆	☆	☆	☆	☆	☆	☆	☆	☆	☆						
	Manual Image Density	☆	☆	☆	-	☆	☆	☆	☆	☆	→	☆	☆	☆	→	☆	☆	☆	☆	☆	☆						
Color Mode	Full Color	★	☆	X	☆	-	→	→	→	☆	☆	☆	☆	☆	→	☆	☆	☆	☆	☆	☆						
	Black&White	★	☆	☆	☆	→	-	→	→	☆	→	→	☆	☆	→	☆	☆	☆	☆	☆	☆						
	Single Color	★	☆	☆	☆	→	→	-	→	☆	→	→	☆	☆	→	☆	☆	☆	☆	☆	☆						
	Twin Color	★	☆	☆	☆	→	→	→	-	☆	→	→	X	☆	→	X	☆	☆	☆	☆	☆						
Color Creation	Original Image Type Selection	★	☆	☆	☆	☆	☆	☆	☆	-	→	☆	☆	☆	→	☆	☆	☆	☆	☆	☆						
	Type Mask	★	☆	☆	X	☆	X	X	X	☆	-	→	→	→	→	X	☆	☆	☆	☆	☆						
	Color Conversion	★	☆	☆	☆	☆	X	X	X	☆	→	-	☆	☆	→	X	☆	☆	☆	☆	☆						
	Color Erase	★	☆	☆	☆	☆	☆	☆	X	☆	→	-	☆	☆	→	X	☆	☆	☆	☆	☆						
	Color Background	★	☆	☆	☆	☆	☆	☆	☆	☆	→	☆	☆	☆	-	→	X	☆	☆	☆	☆						
Image Creation	Paint	★	☆	X	X	X	X	X	X	→	→	→	→	→	-	X	X	X	X	☆	☆						
	Outline Image	★	☆	☆	☆	☆	☆	☆	X	X	X	X	X	X	X	-	☆	☆	☆	☆	☆						
	Shadow Image	★	☆	☆	☆	☆	☆	☆	☆	☆	☆	☆	☆	☆	X	☆	-	☆	☆	☆	☆						
	Slanted Image	★	X	☆	☆	☆	☆	☆	☆	☆	☆	☆	☆	☆	→	☆	-	☆	☆	☆	☆						
	Mirror Image	★	X	☆	☆	☆	☆	☆	☆	☆	☆	☆	☆	☆	→	☆	☆	☆	☆	-	☆						
	Positive/Negative	★	☆	☆	☆	☆	☆	☆	☆	☆	☆	☆	☆	☆	☆	☆	☆	☆	☆	☆	-						

	①	②	③ Newly selected mode																	
			Density	Color Mode					Color Creation					Image Creation						
				Auto Image Density	Manual Image Density	Full Color	Black & White	Single Color	Twin Color	Original Image Type Selection	Type Mask	Color Conversion	Color Erase	Color Background	Paint	Outline Image	Shadow Image	Slanted Image	Mirror Image	Positive/Negative
Image Adjustment	Soft/Sharp	★	☆	☆	☆	☆	☆	☆	☆	☆	☆	☆	☆	☆	☆	☆	☆	☆	☆	
	Contrast	★	☆	☆	☆	☆	☆	☆	☆	☆	☆	☆	☆	☆	☆	☆	☆	☆	☆	
	Background Density	★	☆	☆	☆	☆	☆	☆	☆	☆	☆	☆	☆	☆	☆	☆	☆	☆	☆	
	Pastel	★	☆	☆	☆	☆	☆	☆	☆	☆	☆	☆	☆	☆	☆	☆	☆	☆	☆	
	U.C.R Adjustment	★	☆	☆	☆	☆	☆	☆	☆	☆	☆	☆	☆	☆	☆	☆	☆	☆	☆	
	Text/Photo Sensitivity	✕	☆	☆	☆	☆	☆	☆	☆	☆	☆	☆	☆	☆	☆	☆	☆	☆	☆	
Color Adjustment	Color Adjustment	★	☆	☆	☆	☆	→	→	→	→	☆	☆	☆	→	→	☆	☆	☆	☆	
	Color Balance Adjustment	★	☆	☆	☆	☆	☆	☆	☆	☆	→	☆	☆	☆	☆	→	☆	☆	☆	
	Save Area	☆	☆	☆	☆	☆	☆	☆	☆	☆	☆	☆	☆	☆	☆	☆	☆	☆	☆	
	Delete Area	☆	✕	✕	✕	✕	✕	✕	✕	✕	✕	✕	✕	✕	✕	✕	✕	✕	✕	
Image Adjustment	Preset Reduce/Enlarge/Zoom	✕	✕																	
	Size Magnification	✕	✕																	
	Directional Magnification	✕	✕																	
	Poster Mode	✕	✕																	
	Auto Reduce/Enlarge	✕	✕																	
	Centering/Cornering, Margin Adjustment	✕	✕																	
	Center Erase, Center/Border Erase, Border Erase	✕	✕																	
	Duplex/Combine	✕	✕																	
	Auto Paper Select	✕	✕																	
	Bypass Tray Copying	✕	✕																	
	Program	✕	✕																	
	Interrupt Copying	✕	✕																	
	Sort/Stack/Staple (Option)	✕	✕																	

		③										④										⑤
		Newly selected mode																				
		Image Adjustment																				
		Soft/Sharp	Contrast	Background Density	Pastel	U.S.R. Adjustment	Text/Photo Sensitivity	Color Adjustment	Color Balance Adjustment	Save Area	Delete Area	Rectangle	Right Angle Polygon	Polygon	Closed Loop	Multi-Closed Loop	Line	Rectangle Frame	Right Angle Polygon frame	Polygon frame		
Image Density	Auto Image Density	☆	☆	☆	☆	☆	☆	☆	☆	☆	→	☆	☆	☆	☆	☆	--	--	--	--		
	Manual Image Density	☆	☆	☆	☆	☆	☆	☆	☆	☆	→	☆	☆	☆	☆	☆	--	--	--	--		
Color Mode	Full Color	☆	☆	☆	☆	☆	☆	☆	☆	☆	→	☆	☆	☆	☆	☆	--	--	--	--		
	Black&White	☆	☆	☆	☆	☆	☆	✗	☆	☆	→	☆	☆	☆	☆	☆	--	--	--	--		
	Single Color	☆	☆	☆	☆	☆	☆	✗	☆	☆	→	☆	☆	☆	☆	☆	--	--	--	--		
	Twin Color	☆	☆	☆	☆	☆	☆	✗	☆	☆	→	☆	☆	☆	☆	☆	--	--	--	--		
Original Image Type Selection		☆	☆	☆	☆	☆	☆	☆	☆	☆	→	☆	☆	☆	☆	☆	--	--	--	--		
Color Creation	Type Mask	✗	☆	✗	✗	☆	✗	✗	☆	☆	→	☆	☆	☆	✗	✗	--	--	--	--		
	Color Conversion	☆	☆	☆	☆	☆	☆	☆	☆	☆	→	☆	☆	☆	✗	✗	--	--	--	--		
	Color Erase	☆	☆	☆	☆	☆	☆	☆	☆	☆	→	☆	☆	☆	☆	☆	--	--	--	--		
	Color Background	☆	☆	☆	☆	☆	☆	☆	☆	☆	→	☆	☆	☆	☆	☆	--	--	--	--		
	Paint	✗	☆	✗	☆	☆	✗	✗	☆	☆	→	☆	☆	☆	☆	☆	--	--	--	--		
	Outline Image	✗	☆	✗	✗	☆	☆	✗	✗	☆	☆	→	☆	☆	☆	✗	✗	--	--	--	--	
Image Creation	Shadow Image	☆	☆	☆	☆	☆	☆	☆	☆	☆	→	☆	☆	☆	✗	✗	--	--	--	--		
	Slanted Image	☆	☆	☆	☆	☆	☆	☆	☆	☆	→	☆	✗	✗	✗	✗	--	--	--	--		
	Mirror Image	☆	☆	☆	☆	☆	☆	☆	☆	☆	→	☆	✗	✗	✗	✗	--	--	--	--		
	Positive/Negative	☆	☆	☆	☆	☆	☆	☆	☆	☆	→	☆	☆	☆	✗	✗	--	--	--	--		
	Soft/Sharp	--	☆	☆	☆	☆	☆	☆	☆	☆	→	☆	☆	☆	☆	☆	--	--	--	--		
Image Adjustment	Contrast	☆	--	☆	☆	☆	☆	☆	☆	☆	→	☆	☆	☆	☆	☆	--	--	--	--		
	Background Density	☆	☆	--	☆	☆	☆	☆	☆	☆	→	☆	☆	☆	☆	☆	--	--	--	--		
	Pastel	☆	☆	☆	--	☆	☆	☆	☆	☆	→	☆	☆	☆	☆	☆	--	--	--	--		
	U.C.R Adjustment	☆	☆	☆	☆	--	☆	☆	☆	☆	→	☆	☆	☆	☆	☆	--	--	--	--		
	Text/Photo Sensitivity	☆	☆	☆	☆	☆	--	☆	☆	☆	→	☆	☆	☆	☆	☆	--	--	--	--		
	Color Adjustment	☆	☆	☆	☆	☆	☆	--	☆	☆	→	☆	☆	☆	☆	☆	--	--	--	--		
Color Balance Adjustment	☆	☆	☆	☆	☆	☆	--	☆	☆	→	☆	☆	☆	☆	☆	--	--	--	--			
Save Area	☆	☆	☆	☆	☆	☆	☆	☆	--	☆	✗	✗	✗	✗	✗	--	--	--	--			
Delete Area	✗	✗	✗	✗	✗	✗	✗	✗	✗	--	☆	☆	☆	☆	☆	--	--	--	--			













	③											④											⑤
	Newly selected mode																						
	Image Adjustment																						
	Soft/Sharp	Contrast	Background Density	Pastel	U.S.R. Adjustment	Text/Photo Sensitivity	Color Adjustment	Color Balance Adjustment	Save Area	Delete Area	Rectangle	Right Angle Polygon	Polygon	Closed Loop	Multi-Closed Loop	Line	Rectangle Frame	Right Angle Polygon frame	Polygon frame				
Preset Reduce/Enlarge/Zoom																					☆		
Size Magnification																						☆	
Directional Size Magnification																						☆	
Poster Mode																						☆	
Auto Reduce/Enlarge																						☆	
Centering/Cornering, Margin Adjustment																						☆	
Center Erase, Center/Border Erase, Border Erase																						✕	
Duplex/Combine																						✕	
Auto Paper Select																						✕	
Bypass Tray Copying																						☆	
Program																						☆	
Interrupt Copying																						✕	
Sort/Stack/Staple (Option)																						☆	

5

6. Troubleshooting

If Your Machine Does not Operate as You Want

Check the following:

Condition	Action
Nothing happens when the operation switch is turned on.	Is the main power switch turned on? → Turn on the main power switch.
 Paper tray is empty.	Load paper. ⇒ P.192 "  Loading Paper".
 Toner cartridge is almost empty. Or toner container is empty.	Add toner. ⇒ P.196 "  Changing The Toner Cartridge".
 Doors/covers are open.	Close the doors/covers.
 Misfeed occurs.	Remove misfed paper. ⇒ P.198 "  Clearing Misfeeds".
 The machine instructs you to add staples.	Add staples. ⇒ P.201 "  Adding Staples".
The machine instructs you to enter your user code.	The machine is set for User Code mode. Enter your user code. ⇒ P.217 "General Features".
The Energy Saver indicator is on.	Your machine is under the energy saver condition. → Press the [Energy Saver] key. ⇒ P.52 "Energy Saver Mode".
Misfeeds occur frequently.	Is the right kind of paper in the paper tray? → Paper size and weight must be within the specifications for this machine.
	Is folded, wrinkled, damp, or curled paper in the paper tray? → Always use dry, undamaged paper.
	Is the paper properly set in the paper tray? → Always load paper correctly.
	Are there any pieces of misfed paper or other foreign objects in the machine? → Make sure that the paper path is completely clear of paper and other material after a misfeed.
Staples do not come out at all.	There are jammed staples in the stapler. → Remove the jammed staples. ⇒ P.203 "  Removing Jammed Staples".
	After loading a new staple cartridge, staples might not be ejected the first few times you try to use the stapler.
 or  or  is lit	Contact your service representative.



Condition	Action
The machine cannot detect the original size.	Place custom size original on the exposure glass.
	Enter both horizontal and vertical sizes of the custom original. ⇒ P.45 <i>"Copying onto custom size paper with the bypass tray"</i> .
	Select paper manually, not in Auto Paper Select mode.
	Do not use Auto Reduce/Enlarge mode.
	Place your originals.
The machine instructs you to check the original direction.	Place the original in the same direction as the copy paper.
The machine instructs you to check paper size.	Select the proper paper size.
The machine cannot sort this size paper.	Select the proper paper size that can be used in Sort mode. ⇒ P.116 <i>"Sort"</i> .
The machine cannot stack this size paper.	Select the proper paper size that can be used in Stack mode. ⇒ P.117 <i>"Stack"</i> .
You cannot enter the desired copy set number.	You can change the maximum copy quantity that you can make at a time. ⇒ P.217 <i>"General Features"</i> .
The machine instructs you to set the duplex tray.	Reset the duplex tray correctly. ⇒ P.4 <i>"Guide to Components"</i> .
The machine instructs you to wait.	Wait for the machine to warm-up.
The panel display is off.	Press the [Energy Saver] key to cancel Energy Saver mode.
	Turn on the operation switch.
	Adjust the Screen Contrast. ⇒ P.7 <i>"Operation Panel"</i> .

If you cannot correct the problem by taking the above actions, please contact your service representative.

If You Cannot Make Copies as You Want

Problem	Cause	Action
Copies appear dirty.	The image density is too dark.	Adjust the image density. ⇒ P.28 " <i>Adjusting Copy Image Density</i> ".
		Adjust the background density. ⇒ P.142 " <i>Image Adjustment</i> ".
The reverse side of an original image is copied.	The exposure glass or document feeder belt is dirty.	Clean them. ⇒ P.230 " <i>Maintaining Your Machine</i> ".
		Adjust the image density. ⇒ P.28 " <i>Adjusting Copy Image Density</i> ".
A shadow is copied when copying a pasted original.	The image density is too dark.	If you select Black & White Copy mode or Single Color mode, place a black paper in the backside of the original and select Auto Image Density mode.
		Lighten the background density. ⇒ P.142 " <i>Image Adjustment</i> ".
		Adjust the image density. ⇒ P.28 " <i>Adjusting Copy Image Density</i> ".
Copies are too light.	The original has a low contrast image.	Adjust the background density. ⇒ P.142 " <i>Image Adjustment</i> ".
		Place the original in a different direction.
		Put mending tape on the bound part.
		Adjust the image density. ⇒ P.28 " <i>Adjusting Copy Image Density</i> ".
Copies are too light.	The image density is too light.	Adjust the image density. ⇒ P.28 " <i>Adjusting Copy Image Density</i> ".
	Damp or rough grain paper is used	Use dry paper without rough grain.

Problem	Cause	Action
Copy image is not clear.	The original image type is not selected properly.	Select the proper original image type. ⇒ P.28 "Adjusting Copy Image Density".
		Adjust the sharpness of the image with the Soft/Sharp function. ⇒ P.142 "Image Adjustment".
The same copy area is dirty whenever making copies.	The exposure glass or document feeder belt is dirty.	Clean them. ⇒ P.230 "Maintaining Your Machine".
When using Enlarge mode, shadows appear on the margins of copies.	Shadows may appear because the whole surface area of the exposure glass was scanned in.	Select the Border Erase mode. ⇒ P.86 "Erase".
Copies are blank or parts of the image are not copied.	The original is not placed correctly.	Place the originals correctly.
	An improper paper size is selected.	Select the proper paper size.
	The selected reproduction ratio does not match the paper size.	Select the proper reproduction ratio.
A moire pattern is produced on copies as shown in the illustration. 	Text mode is selected.	Select Auto Original Type Select mode or Photo mode. ⇒ P.36 "Selecting the Original Image Type".
	The line images of the original might be overlapped with each other.	Place the original on the exposure glass at a slight angle.
		Adjust the sharpness of the image. ⇒ P.142 "Image Adjustment".
Color tone of copies is different from that of originals.	The color balance is not set properly.	Adjust the Color Balance. ⇒ P.131 "Color Balance Adjustment".
		Perform the Auto Color Calibration (A.C.C.). ⇒ P.142 "Image Adjustment".
Color tone of copies is completely different from that of originals.	Unsuitable color setting.	Perform Auto Color Calibration (A.C.C.). ⇒ P.142 "Image Adjustment". If you cannot correct the problem by performing Auto Color Calibration, contact your service representative.

Problem	Cause	Action
Letter parts and photo parts of an original are not separated correctly.	An original has screen letters or low density letters.	Adjust the Text/Photo Sensitivity to a "Text" level. ⇒ P.142 "Image Adjustment".
	An original has a high contrast photo.	Adjust the Text/Photo Sensitivity to a "Photo" level. ⇒ P.142 "Image Adjustment".
	An original has a photo having a sequence of thin lines with regular thin spaces.	
Color parts of an original are copied in black in Auto Color Select mode.	The original image contains small or thin color parts.	Adjust the A.C.S. Sensitivity to a "Full color" level. ⇒ P.142 "Image Adjustment".
Non-color parts of an original are copied in color in Auto Color Select mode.	The machine might detect some black and white screen images (such as from newspaper) as a full color original.	Select Black & White mode. ⇒ P.31 "Black & White copy mode".
		Adjust the A.C.S. Sensitivity to a "B&W" level. ⇒ P.142 "Image Adjustment".
A copy image is blurred.	The image density is too light.	Adjust the image density. ⇒ P.28 "Adjusting Copy Image Density".
	An improper kind of paper is loaded.	Load the right kind of paper in the paper tray.  Note <input type="checkbox"/> Copies might be blurred if you copy onto rough grain, coated, or damp paper.
	Toner is running out.	Add toner. ⇒ P.196 "  Changing The Toner Cartridge".
In Margin Adjustment mode, parts of the original image are not copied.	The margin is set too wide.	Set the narrow margin with the user tools. ⇒ P.217 "General Features".
In Repeat Image mode, the original image is not copied repeatedly.	An improper reproduction ratio is selected.	Select the proper reproduction ratio.

If you cannot correct the problem by taking the above actions, please contact your service representative.

Loading Paper

Reference

For details about paper sizes that can be set, ⇒ P.235 “Mainframe”.

Note

If you want to change the paper size, ⇒ P.207 “Changing Paper Size”.

Non-recommended Paper for Paper Trays

- Folded, curled, creased, or damaged paper
- Torn paper
- Perforated paper
- Paper with conductive or low electrical resistance coating such as carbon or silver coating
- Thermal paper, art paper
- Thin paper that has low stiffness
- Damp paper
- Wavy paper
- Stapled paper
- Translucent paper
- OHP transparencies

Note

- Load paper with the side you wish to copy onto face-down in the paper trays. If copies are curled, try turning the copy paper over in the tray. If there is no improvement, change to copy paper with less curl.
- Correct curls in copy paper before loading.
- Fan copy paper to get air between the sheets before loading.
- When making 2-sided copies, do not load paper in the paper tray to copy on the reverse side. Use the bypass tray. ⇒ P.49 “Copying onto the reverse side of paper”.

Loading Paper in the Paper Tray

- 1** Pull out the paper tray until it stops.
- 2** While pressing the lock lever, open the side fences.

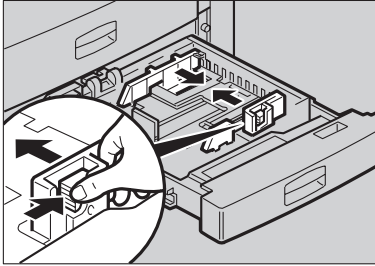

TCAY060E

- 3** Square the paper and load it in the tray.

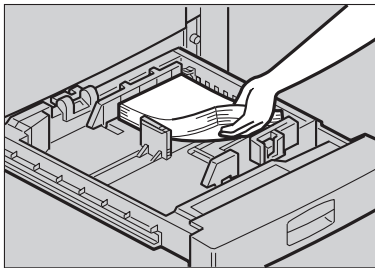

TCAY060E

Note

- Do not stack paper over the limit mark.
- Make sure that the leading corners of the paper are under the corners.

- 4** Reinstall the side fences.
- 5** Push the paper tray in until it stops.

Loading Paper in the Large Capacity Tray

- 1 Press the **[Down]** key if it is not lit.

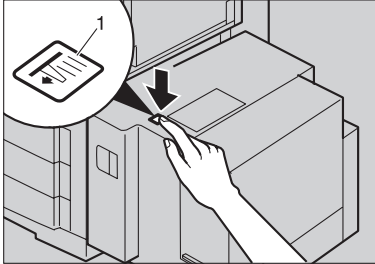

TCAP020E

1. Down key

 **Note**

- The key blinks while the bottom plate is moving down.

- 2 When the key stops blinking and lights up, open the top cover.

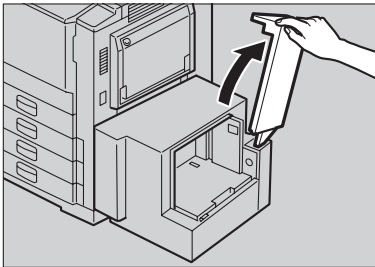

TCAP030E

 **Note**

- Make sure no paper sheet is in the feeding part of the Large Capacity Tray. Remove the sheet, if any.

- Place the paper in the tray along the edge on the left.

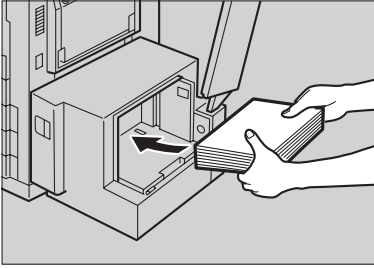

TCAP040E

 **Note**

- The Tray contains up to 1,500 sheets.

- Close the top cover.

Changing The Toner Cartridge

There are four kinds of toner (Cyan, Magenta, Yellow, and Black). When  is lit, it is time to add toner.

⚠ WARNING:

- *Do not incinerate used toner or toner containers. Toner dust might ignite when exposed to an open flame. Dispose of used toner containers in accordance with local regulations for plastics.*

⚠ CAUTION:

- *Keep toner (used or unused) and toner containers out of reach of children.*

⚠ CAUTION:

- *Our products are engineered to meet high standards of quality and functionality, and we recommend that you only use the expendable supplies available at an authorized dealer.*

Note

- If you use toner other than that recommended, a fault might occur.
- When changing the toner cartridge, do not turn off the operation switch. If you do, your settings are cleared.
- Always add toner after the machine instructs you to add toner.
- Do not use used toner. This will damage the machine.
- Be sure to add the correct color toner.
- You can still make about 20 copies after  appears. This is a good time to get a new toner cartridge ready.

1 Open the front cover of the machine.

2 Turn the knob clockwise to the position shown in the diagram.

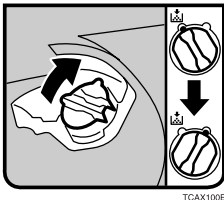

3 Pull out the toner cartridge.

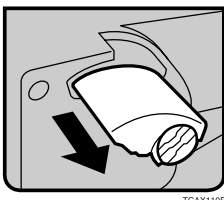

4 Remove the seal.

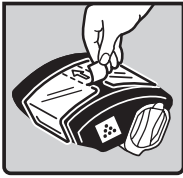

ZEBX270E

5 Push in the new toner cartridge until it fits into place.

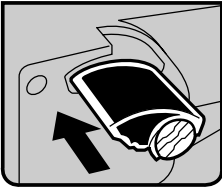

TCAX190E

6 Turn the knob back to the position shown and close the front door.

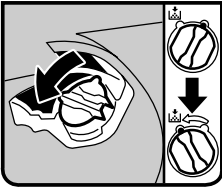

TCAX140E

Note

- Insert the new toner cartridge until it stops.
- After inserting the new toner cartridge, turn the knob counterclockwise to the ▼ mark.

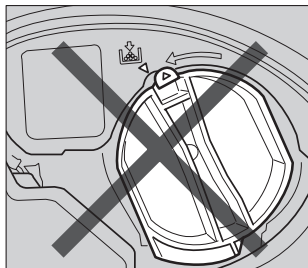
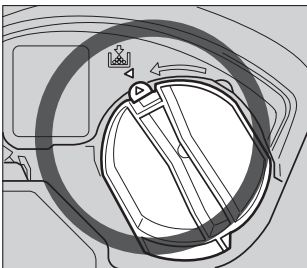

ZEAH130U

Clearing Misfeeds

⚠ CAUTION:

- *The fusing section of this equipment might be very hot. You should be very careful that you don't touch this section when removing the misfed paper.*

📌 Note

- When clearing misfeeds, do not turn off the operation switch. If you do, your copy settings are cleared.
- To prevent misfeeds, do not leave any torn scraps of paper within the machine.
- If paper misfeeds occur repeatedly, contact your service representative.
- When clearing misfeeds, make sure that all units and levers are returned to their original position and all covers are closed.
- Do not touch originals in the document feeder when a paper misfeed occurs in the machine. If you do the machine cannot determine which originals have been copied and which have not.

6

Check the Misfeed Location Display

The display shows the location of misfed paper.

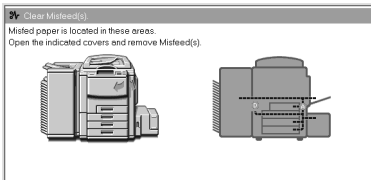

Clearing Paper Misfeeds

When A, B, C, D or Z is Displayed:

- 1** Open the front cover of the machine.
- 2** You can find the sticker (with ✂ at the top) explaining how to remove misfed paper inside the front cover as shown in the illustration.

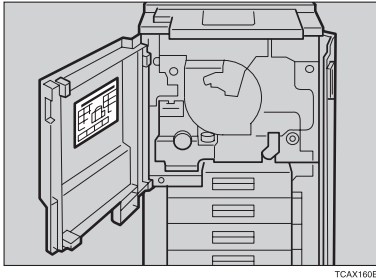

- 3** Remove misfed paper following the instructions on the sticker.

When R is Displayed:

 **Note**

- This indicator is displayed only when your machine is equipped with the optional 20-bin sorter stapler.

- 1** Open the top cover of the sorter.
- 2** You can find the sticker (with ✂ at the top) explaining how to remove the misfed paper on the 20-bin sorter stapler as shown in the illustration.

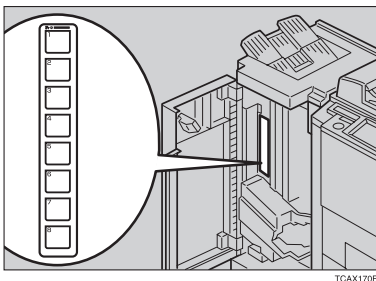

- 3** Remove the misfed paper following the instructions on the sticker.

When P is Displayed:

 **Note**

- This indicator is displayed only when your machine is equipped with the optional document feeder.

1 You can find the sticker (with  at the top) explaining how to remove the misfed paper on the document feeder as shown in the illustration.

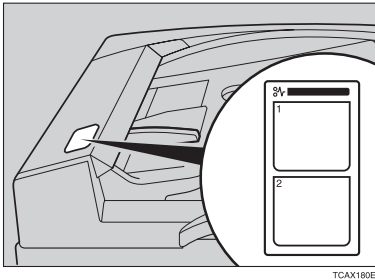

2 Remove the misfed paper following the instructions on the sticker.

When U is Displayed:

 **Note**

- This indicator is lit only when your machine is equipped with the optional large capacity tray.

1 You can find the sticker (with  at the top) explaining how to remove the misfed paper on the large capacity tray as shown in the illustration.

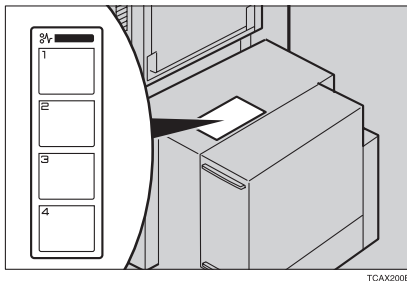

2 Remove the misfed paper following the instructions on the sticker.

Adding Staples

⚠ CAUTION:

- Our products are engineered to meet high standards of quality and functionality, and we recommend that you only use the expendable supplies available at an authorized dealer.

📌 Note

- ☐ If you use a staple cartridge other than that recommended, staple failure or staple jams might occur.

1 Open the sorter stapler front cover, pull the R3 holder, and then pull out the stapler unit.

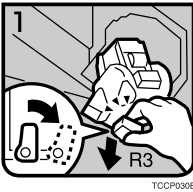

2 Push the cartridge forward to release it.

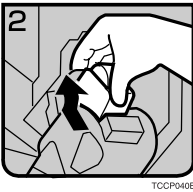

3 Pull out the cartridge.

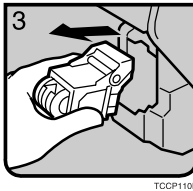

4 Remove the empty refill in the arrow direction.

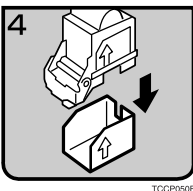

- 5** Align the arrow mark on the new refill with that on the cartridge and push the new refill into the cartridge until a click is heard.

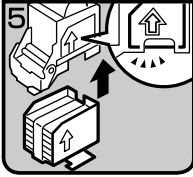

- 6** Pull the ribbon out of the cartridge.

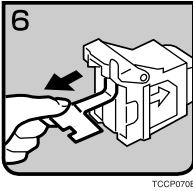

- 7** Place the cartridge in the stapler unit.



- 8** Turn the cartridge backward until a click is heard.

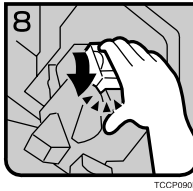

- 9** Return the R3 holder back to its original position.

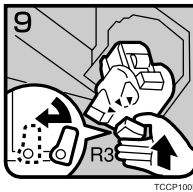

- 10** Close the sorter stapler front cover.

Removing Jammed Staples

Note

- Staples might be jammed because of curled copies. In this case, try turning the copy paper over in the tray. If there is no improvement, change to copy paper with less curl.
- After removing jammed staples, staples might not be ejected the first few times you try to use the stapler.

1 Open the sorter stapler front cover, and then turn the dial in the arrow direction until the staple unit stops.

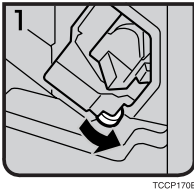

2 Pull the R3 holder, and then pull out the staple unit.

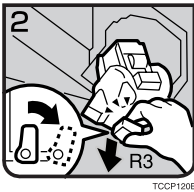

3 Push the cartridge forward to release it.

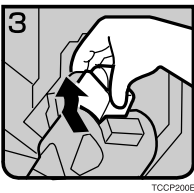

4 Pull out the cartridge.

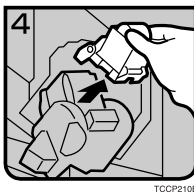

5 Push the lock on the right side of the phase plate to open the phase plate.

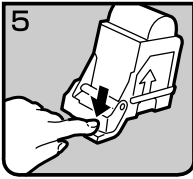

TCCP130E

6 Remove the jammed staple.

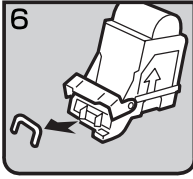

TCCP140E

7 Return the phase plate to its original position until a click is heard.

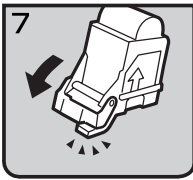

TCCP150E

8 Place the cartridge in the staple unit.

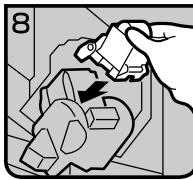

TCCP160E

9 Turn the cartridge backward until a click is heard.

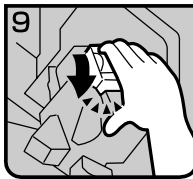

TCCP190E

- 10 Return the R3 holder into the original position.

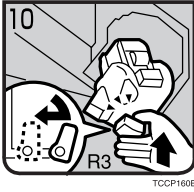

- 11 Close the sorter stapler front cover.

7. Changing the Machine's Settings

Changing Paper Size

1st Tray Paper Size

Note

- Be sure select the paper size with the user tools or misfeeds might occur.

Reference

For paper sizes, weight, and capacity that can be set in each tray, ⇒ P.235 "Mainframe".

1 Make sure that the paper tray is not being used.

2 Pull out the paper tray until it stops.

Note

- Remove any remaining copy paper.

3 Adjust the back fence to the new paper size.

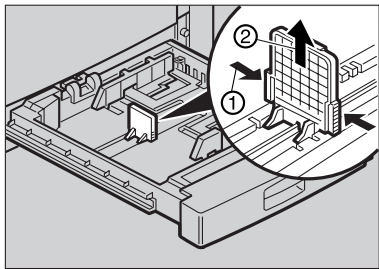

TCAY010E

4 Square the paper and load it in the tray.

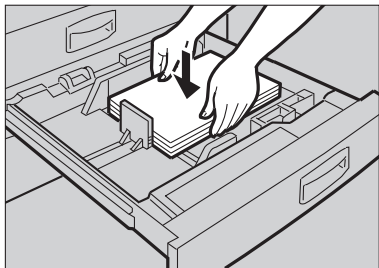

TCAY020E

 **Note**

- Shuffle the paper before loading it in the tray.
- Do not stack paper over the limit mark.
- Make sure the leading corners of the paper are under the corners.

5 While pressing the release levers, slide the side fences to the new paper size.

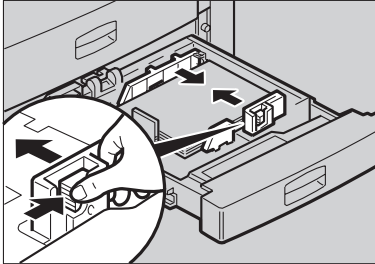

TCAY030E

6 Push the paper tray in until it stops.

7 Press the **[User Tools]** key.

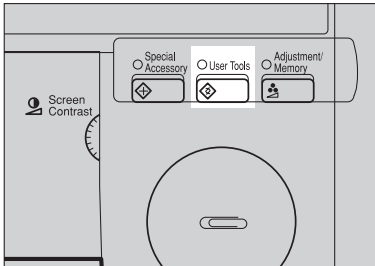

ZEB8470N

 **Reference**

For details about how to change the paper size, ⇒ P.209 “*Changing Paper Size with the User Tools*”.

2nd and 3rd Tray Paper Size

- 1** Follow steps **1** to **5** on ⇒ P.207 “1st Tray Paper Size”.
- 2** Adjust the tray size with the paper size selector to the new paper size.

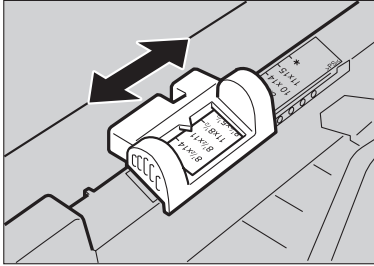

ZEBH390N

Note

- If you cannot find the desired paper size on the paper size selector, select the ✖, and then press the **[User Tools]** key. ⇒ P.209 “Changing Paper Size with the User Tools”.

- 3** Push the paper tray in until it stops.

Changing Paper Size with the User Tools

- 1** Follow steps **1** to **6** on ⇒ P.207 “1st Tray Paper Size”.
- 2** Press the **[User Tools]** key.

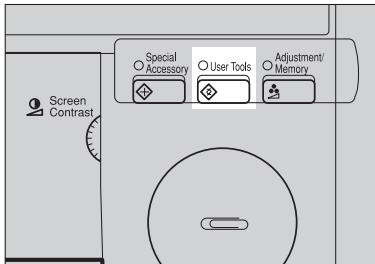

ZEB8470N

3 Press the [System Settings] key.

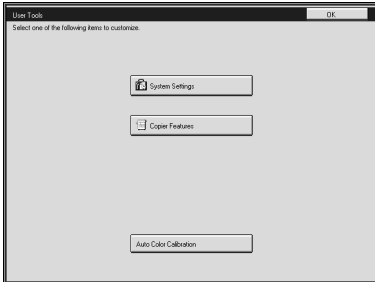

4 Press the [Next] key until Tray Paper Size is displayed.

5 Press the [Change] key to select the tray.

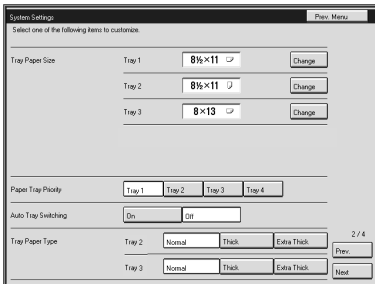

6 Select the paper size, and then press the [OK] key.

7 Press the [User Tools] key to exit from the user tools.

User Tools

Accessing the User Tools

This section is for the key operators in charge of this machine. You can change or set the machine's default settings.

Note

- Do not forget to exit the user tools menu after accessing it.

1 Press the **[User Tools]** key.

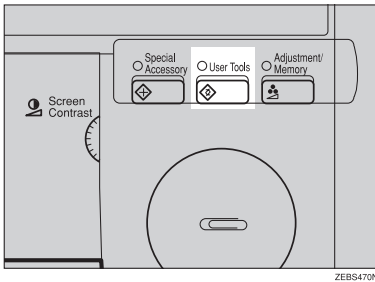

2 Press the **[System Settings]** or **[Copier Features]** key.

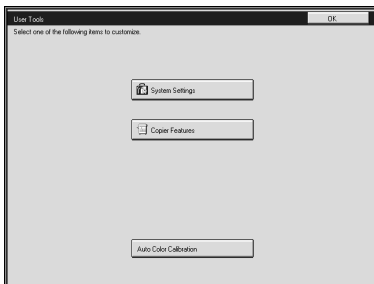

3 Select the desired user tools menu.

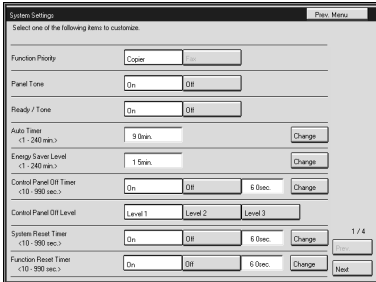

Note

- [Next]:** Press to go to the next page.
- [Prev.]:** Press to go back to the previous page.

4 Change the settings by following the instructions on the panel display.

Note

- [Prev. Menu]** key: Press to return to the previous menu.
- [Cancel]** key: Press to return to the previous menu without changing any data.

7 **Exiting from the User Tools**

1 After changing the user tools settings, press the **[User Tools]** key.

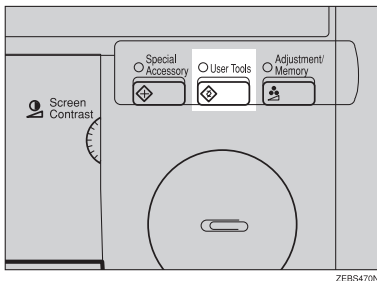

Note







- The settings are not canceled even if the operation switch is turned off or the **[Clear Modes]** key is pressed.







Setting You can Change with the User Tools (System Settings)





Reference





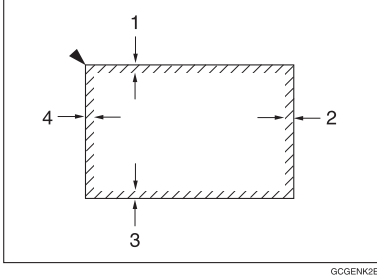

For details about how to access the user tools, ⇒ P.211 “Accessing the User Tools”.

System settings

Menu	Description
Function Priority	<p>You can specify the mode to be displayed immediately after the operation switch is turned on or System Reset Timer mode is turned on.</p> <p> Note <input type="checkbox"/> Default: <i>Copier</i></p>
Panel Tone	<p>A tone sounds when a key is pressed. This beeper can be turned on or off.</p> <p> Note <input type="checkbox"/> Default: <i>On</i></p>
Ready / Tone	<p>Choose whether the machine beeps when it becomes ready for a copy run after power up.</p> <p> Note <input type="checkbox"/> Default: <i>On</i> <input type="checkbox"/> When the “Panel Tone” is set to Off, the beeper does not sound even if the “Ready/Tone” is set to On.</p>
Auto Timer	<p>The machine turns itself off automatically to conserve energy after your job is finished, after the selected time. This function is called “Auto Off”. The time can be set from 1 to 240 minutes.</p> <p> Note <input type="checkbox"/> Default: <i>90 minutes</i></p>
Energy Saver Level	<p>The machine enters Low Power mode automatically a certain time after your job is finished. You can set this time between 1 and 240 times.</p> <p> Note <input type="checkbox"/> Default: <i>15 minutes</i></p>
Control Panel Off Timer	<p>The machine enters Energy Saver mode automatically after your job is finished, after the selected time. The time can be set from 10 to 990 seconds (in 10 seconds steps), or off. In Energy Saver mode, the panel display turns off.</p> <p> Note <input type="checkbox"/> Default: <i>On (60 seconds)</i></p>

Menu	Description
Control Panel Off Level	<p>The machine enters Energy Saver mode automatically after your job is finished.</p> <p>Three Energy Saver levels are available:</p> <ul style="list-style-type: none"> • Level 1 The back light of the panel display goes off. Warm-up time: 0 seconds • Level 2 Power consumption is a 25% decrease compared to stand-by. Warm-up time: Approximately 170 seconds • Level 3 Power consumption is a 40% decrease compared to stand-by. Warm-up time: Approximately 260 seconds <p> Note <input type="checkbox"/> Default: <i>Level 1</i></p>
System Reset Timer (Printer Option Required)	<p>The machine returns to its prioritized mode automatically a certain time after your job is finished, after the selected time. The time can be set from 10 to 990 seconds (in 10 seconds steps), or off.</p> <p> Note <input type="checkbox"/> Default: <i>On (60 seconds)</i></p>
Function Reset Timer (Printer Option Required)	<p>When Interleave Print is turned on and a print job comes along while the machine is busy printing another job, this delay specifies how long the machine will wait before switching to the priority print job.</p> <p>The time can be set from 10 to 990 seconds.</p> <p> Note <input type="checkbox"/> Default: <i>On (60 seconds)</i></p>
Tray Paper Size	<p>Select the size of the copy paper set in the paper tray.</p> <p> Note <input type="checkbox"/> If the specified paper size differs from the size of paper actually set in the paper tray, a paper misfeed might occur because the paper size is not detected correctly.</p> <p> Reference For details, ⇒ P.235 “Mainframe”.</p>
Paper Tray Priority	<p>You can select the paper tray which will be selected as a default in the following conditions:</p> <ul style="list-style-type: none"> • When the main power switch or operation switch is turned on. • When System Reset or Auto Reset mode is turned on. • When the [Clear Modes] key is pressed. • When the Auto Paper Select mode is not selected. <p> Note <input type="checkbox"/> Default: <i>Tray 1</i></p>

Menu	Description
Auto Tray Switching	<p>If you load paper of the same size in two or more trays, the machine automatically shifts to another tray when the tray in use runs out of paper. You can set or cancel this setting.</p> <p> Note</p> <ul style="list-style-type: none"> <input type="checkbox"/> Default: <i>Off</i> <input type="checkbox"/> This function is not available in Area Editing Mode.
Tray Paper Type	<p>You can specify the weight of the copy paper set in paper tray 2 and 3.</p> <p> Note</p> <ul style="list-style-type: none"> <input type="checkbox"/> Default: <i>Normal</i>
3 Side Full Bleed	<p>When this mode is off, narrow margins on all 4 sides of the original are not copied.</p> <div data-bbox="344 520 721 795" style="text-align: center;">  </div> <p>1: 2±2mm, 0.08"±0.08" 2: 2±2mm, 0.08"±0.08" 3: 2±2mm, 0.08"±0.08" 4: 4±2mm, 0.16"±0.08"</p> <p>When you turn it on, margins 1, 2 and 3 are copied.</p> <p> Note</p> <ul style="list-style-type: none"> <input type="checkbox"/> Default: <i>Off</i> <input type="checkbox"/> You cannot cancel the leading edge margin (margin 4). <input type="checkbox"/> 4mm, 0.16" of the trailing edge margin might become blurred in Thick and Extra Thick mode.







Menu	Description
Bypass Tray Custom Size	<p>You can register the custom size paper when you make copies with the bypass tray.</p> <ol style="list-style-type: none"> ① Press the [Change] key. ② Enter the horizontal size with the number keys, and then press the [#] key. ③ Enter the vertical size with the number keys, and then press the [#] key. <p> Note</p> <ul style="list-style-type: none"> <input type="checkbox"/> Adjustment value: <ul style="list-style-type: none"> • Metric version: <ul style="list-style-type: none"> Vertical: 100 - 330mm Horizontal: 140 - 483mm • Inch version: <ul style="list-style-type: none"> Vertical: 3.9" - 13.0" Horizontal: 5.5" - 19.0"
Interleave Print (Printer Option Required)	<p>Turn this feature on to give print jobs priority. If a print job comes along while another job is in progress, the current job will be temporarily suspended while the print job is printed.</p> <p> Note</p> <ul style="list-style-type: none"> <input type="checkbox"/> Default: <i>On</i>
Copy Count Display	<p>The copy counter can be set to show the number of copies made (Up), or the number of copies remaining to be made (Down).</p> <p> Note</p> <ul style="list-style-type: none"> <input type="checkbox"/> Default: <i>Up</i>
Display Color Setting	<p>You can change the color of the display editor.</p> <p> Note</p> <ul style="list-style-type: none"> <input type="checkbox"/> Default: <i>Blue</i>
Key Operator Tools	<p>If you select "On", only operators who know the key operator can access the "Key Operator Tools" in the System Settings and Copier Features.</p> <p> Note</p> <ul style="list-style-type: none"> <input type="checkbox"/> Default: <i>Off</i> <input type="checkbox"/> If you select "On", you should register the key operator code.
AOF (Keep It On.)	<p> Note</p> <ul style="list-style-type: none"> <input type="checkbox"/> For details about this function, contact your service representative.







Settings You can Change with the User Tools (Copier Features)

Reference













For details about how to access the user tools, ⇒ P.211 “Accessing the User Tools”.





General Features



Menu	Description
Auto Paper Select Priority	<p>By default, Auto Paper Select is selected just after the machine is turned on or when modes are cleared. You can cancel this setting.</p> <p> Note <input type="checkbox"/> Default: <i>On</i></p>
ADS Priority (FC/Twin)	<p>By default, Manual Image Density is selected in Full Color mode just after the machine is turned on or when modes are cleared. You can cancel this setting so that the Auto Image Density is selected.</p> <p> Note <input type="checkbox"/> Default: <i>Manual</i></p>
ADS Priority (B&W/SC)	<p>By default, Auto Image Density is selected in Black & White, Single Color, and Twin Color mode just after the machine is turned on or when modes are cleared. You can cancel this setting.</p> <p> Note <input type="checkbox"/> Default: <i>Auto Image Density</i></p>
Original Type Priority	<p>You can select the original image type (Auto Original Type Select mode, Text/Photo mode, Text mode, Photo mode, or Special Original mode) that is selected automatically just after the machine is turned on or when modes are cleared.</p> <p> Note <input type="checkbox"/> Default: <i>Text/Photo mode</i></p>
Color Priority	<p>You can select the color mode (Auto Color Select mode, Full Color mode, or Black & White mode) that is selected automatically just after the machine is turned on or when modes are cleared.</p> <p> Note <input type="checkbox"/> Default: <i>Auto Color Select mode</i></p>
Special Orig. Priority	<p>You can select the special original type (Highlight Pen, Inkjet Output, or Map) that is selected automatically just after the machine is turned on or when modes are cleared.</p> <p> Note <input type="checkbox"/> Default: <i>Highlight Pen</i></p>

Menu	Description
Photo Type (Auto Text/Photo)	<p>You can select the photo type (Press Print, Glossy Photo, or 2nd Generation) in Auto Text/Photo mode that is selected automatically just after the machine is turned on or when modes are cleared.</p> <p> Note <input type="checkbox"/> Default: <i>Press Print</i></p>
Photo Type(Photo)	<p>You can select the photo type (Press Print, Glossy Photo, or 2nd Generation) in Photo mode that is selected automatically just after the machine is turned on or when modes are cleared.</p> <p> Note <input type="checkbox"/> Default: <i>Press Print</i></p>
Copy Reset Timer	<p>The machine returns to its initial condition automatically after your job is finished. The time can be set from 10 to 990 seconds, or this function can be turned off.</p> <ol style="list-style-type: none"> ① Select [On] or [Off] keys. ② When you select [On], enter the time with the number keys. Then press the [#] key. <p> Note <input type="checkbox"/> Default: <i>On (60 seconds)</i></p>
Maximum Copy Quantity	<p>The maximum copy quantity can be set from 1 to 999.</p> <p> Note <input type="checkbox"/> Default: <i>Off</i></p>
Tone: Original on Platen	<p>The key tone sounds when you forgot to remove originals after copying.</p> <p> Note <input type="checkbox"/> Default: <i>Off</i> <input type="checkbox"/> When the “Panel Tone” is set to Off, the beeper does not sound even if the “Original Tone” is set to On.</p>
Front Side Margin Adjust.	<p>You can adjust the front side margin direction and width that is selected as a default in “Front Side Margin Adjust.” mode. You can change this setting.</p> <ul style="list-style-type: none"> • Metric version: left/20 mm—right/20 mm in 1 mm steps. • Inch version: left/0.8"—right/0.8" in 0.1" steps. <p> Note <input type="checkbox"/> Default:</p> <ul style="list-style-type: none"> • Metric version: <i>left/right 0mm</i> • Inch version: <i>left/right 0"</i>

7



Menu	Description
Back Side Margin Adjust.	<p>You can adjust the back side margin direction and width that is selected as a default in "Back Side Margin Adjust." mode.</p> <p>You can change this setting.</p> <ul style="list-style-type: none"> • Metric version: left/20 mm—right/20 mm in 1 mm steps. • Inch version: left/0.8"—right/0.8" in 0.1" steps. <p> Note</p> <p><input type="checkbox"/> Default:</p> <ul style="list-style-type: none"> • Metric version: <i>left/right 0mm</i> • Inch version: <i>left/right 0"</i>
1→2 Duplex Auto Margin Adjust.	<p>When you use 1 Sided → 2 Sided mode, the machine sets the back side margin automatically.</p> <p> Note</p> <p><input type="checkbox"/> Default: <i>Off</i></p>
Magnification Setting	<p>Up to 2 reproduction ratios which you frequently use can be registered.</p> <ol style="list-style-type: none"> ① Press the [Setting] key. ② Select the [User Ratio 1] or [User Ratio 2] key. ③ Enter your desired ratio with the number keys, and then press the [OK] key.
Initial Mode Setting	<p>You can set the machine to recall program setting when the machine is turned on or when modes are cleared.</p> <p> Note</p> <p><input type="checkbox"/> Default: <i>Normal</i></p>
Show Editor Grid (Option)	<p>You can turn the grid snap on or off in the display editor. The grids may help you to mark a right angle shape.</p> <p> Note</p> <p><input type="checkbox"/> Default: <i>Off</i></p>
Area Shape Priority	<p>When you designate areas, you can select the first designated shape.</p> <ol style="list-style-type: none"> ① Select the  [Rectangle],  [R.A.Polygon],  [Polygon],  [Closed Loop], or  [Multi. Closed Loop] key. <p> Note</p> <p><input type="checkbox"/> Default:  [Rectangle] key</p>
B&W Copy Default: Text	<p>When you select the Black & White copy mode, you can select text mode regardless of the Original Type Priority setting.</p> <p> Note</p> <p><input type="checkbox"/> Default: <i>Off</i></p>



Menu	Description
Image Rotation	<p>When copying onto copy paper of the same size but different orientation in Auto Paper Select or Auto Reduce/Enlarge mode, rotate the image by 90 degrees.</p> <p> Note <input type="checkbox"/> Default: <i>On</i></p>
Add margin in Repeat Image	<p>You can select whether to add a margin or not.</p> <p> Note <input type="checkbox"/> Default: <i>Off</i></p>
Priority Tray for FC	<p>When copying in Full Color mode, the paper in the selected paper tray can be used.</p> <p> Note <input type="checkbox"/> Default: <i>Off</i></p>
Key Operator Tools	<p>Use these tools to manage use of the machine.</p> <p> Note <input type="checkbox"/> Enter a previously registered key operator code with the number keys.</p> <p> Reference For details about the key operator code, ⇒ P.213 “<i>System settings</i>”.</p>
Accessible Modes Setting	<p>You can assign user codes to each color mode. Operators must enter their user codes before using each color mode (Full color, Black & White, Single, Twin Color).</p> <p>The machine keeps count of the number of copies made under each user code.</p> <p>① Select your desired color mode.</p>

Menu	Description
User Codes Setting	<p>❖ Program</p> <p>You can register the user codes.</p> <ol style="list-style-type: none"> ① Press the [Program] key. ② Enter the user code with the number keys, and then press the [#] key. ③ Select the color mode from [Full Color], [Black & White], [Single], or [Twin Color] key. <p> Note</p> <p><input type="checkbox"/> You can up to 200 user codes.</p>
	<p>❖ Change</p> <p>You can change the user codes.</p> <ol style="list-style-type: none"> ① Press the [Change] key. ② Select the user code. ③ Enter the user code with the number keys, and then press the [#] key. ④ Select the color mode from [Full Color], [Black & White], [Single], or [Twin Color] key.
	<p>❖ Clear</p> <p>You can clear the user codes.</p> <ol style="list-style-type: none"> ① Press the [Clear] key. ② Select the user code that you want to clear. ③ If you want to clear the all user codes of the page, press the [Select All] key. <p> Note</p> <p><input type="checkbox"/> If you want to change the [Select All], press the [Clr All Select] key.</p> <ol style="list-style-type: none"> ④ Press the [OK] key. ⑤ Press the [Yes] key.
	<p>❖ Delete All</p> <p>You can delete the all registered user codes.</p> <ol style="list-style-type: none"> ① Press the [Delete All] key. ② Press the [Yes] key.



Menu	Description
Counter Manager	<p>◆ Counter List Print You can print data for all user codes.</p> <ol style="list-style-type: none"> ① Press the [Counter List Print] key. ② Press the [Print Start] key.
	<p>◆ Reset Counters You can check the number of copies made using each user code. Also, you can clear each code's counter.</p> <ol style="list-style-type: none"> ① Press the [Reset Counters] key. ② Enter the user code with the number keys that you want to check the number of copies for. ③ Press the [OK] key. ④ Press the [Yes] key.
	<p>◆ Delete All You can reset the counter for all user codes.</p> <ol style="list-style-type: none"> ① Press the [Delete All] key. ② Press the [Yes] key.





Image Adjustment

Menu	Description
Background Dens. of A.D.S. (FC/Twin)	<p>The Auto Image Density levels in Full Color mode can be made lighter or darker (5 levels).</p> <p> Note <input type="checkbox"/> Default: <i>level 3</i></p>
A.C.S. Priority	<p>You can select whether color images or black & white images are priority detected in Auto Color Select mode.</p> <p> Note <input type="checkbox"/> Default: <i>Full Color</i></p>
Color Sensitivity	<p>When in Color Erase, Color Conversion or Twin Color (Red & Black) mode, the function can be made more or less sensitive to the color to be erased or converted. It can be adjusted within 5 levels ("Narrow" to "Wide").</p> <p>For example, if red is selected as the color to be erased or converted, "Narrow" will result in only red being erased or converted, and "Wide" will result in other colors close to red being erased or converted.</p> <p> Note <input type="checkbox"/> Default: <i>level 3</i></p>

Menu	Description
Process Black	<p>When copying in full color, 4 colors (Yellow, Magenta, Cyan, and Black) are used by default. You can change this so that only 3 colors (Yellow, Magenta, and Cyan) are used.</p> <p> Note <input type="checkbox"/> Default: 4 colors</p>
Inkjet Output Mode Setting	<p>Specifies the type of image adjustment for Inkjet Output Mode:</p> <ul style="list-style-type: none"> • 1-emphasize yellow • 2-emphasize red and yellow • 3-emphasize red and blue <p>If you want to emphasize yellow, select 1. If you want to emphasize red and yellow, select 2. If you want to emphasize red and blue, select 3.</p> <p> Note <input type="checkbox"/> Default: 1</p>

Duplex/ADF/Sorter

Menu	Description
Duplex Tray Auto Clear	<p>When making two-sided copies from one-sided originals, if the last original is an odd page, the last copy will be automatically delivered with the reverse side blank. You can cancel this setting.</p> <p> Note <input type="checkbox"/> Default: <i>On</i></p>
SADF Auto Reset Timer	<p>When you place one original at a time in the document feeder, the Auto Feed indicator lights for a selected time after an original is fed to show that the document feeder is ready for another original. The time can be set from 1 second to 99 seconds.</p> <p> Note <input type="checkbox"/> Default: 5 seconds</p>
ADF Thin paper	<p>Use when changing the type of originals to be fed. Select this function to avoid damaging thin originals (40 - 52g/m², 11-14 lb) placed in the document feeder.</p> <p> Note <input type="checkbox"/> Default: <i>Off</i></p>

Menu	Description
ADF Mixed Sizes	<p>By default, you cannot place originals of different sizes at one time in the document feeder. You can cancel this setting.</p> <p> Note</p> <ul style="list-style-type: none"> <input type="checkbox"/> Default: <i>Off</i> <input type="checkbox"/> If you select [On], the copying speed will be reduced. <input type="checkbox"/> When placing different length originals, all originals must be flush with the back fence of the document feeder. <input type="checkbox"/> Smaller originals might be skewed a little.
ADF Auto Paper Select	<p>By default, the Auto Paper Select is selected when you load originals in the document feeder. You can cancel this setting.</p> <p> Note</p> <ul style="list-style-type: none"> <input type="checkbox"/> Default: <i>On</i>
Full Color Copy Sorting	<p>You can disable sorting, stacking, or stapling in Full Color mode to maximize quality of full color copies.</p> <p> Note</p> <ul style="list-style-type: none"> <input type="checkbox"/> Default: <i>Off</i>
Auto Sort Mode	<p>You can have the machine select Sort mode automatically when you load two or more originals in the document feeder and make two or more copies from each original.</p> <p> Note</p> <ul style="list-style-type: none"> <input type="checkbox"/> Default: <i>On</i>

Special Mode Program(s)

Special Mode	Use to recall the special modes set by your service engineer.
--------------	---

Auto Color Calibration

Copy Mode/Printer Mode

When the tone of a specific color is strong or the color tone of copies is different from that of originals, perform the procedure below to adjust the balance of the 4 basic colors.

- ① Press the **[Auto Color Calibration]** key.
- ② If your machine has the printer option installed, select Copy Mode or Printer Mode, and then press the **[On]** key.
- ③ Press the **[Print Start]** key.

Note

- The test pattern is delivered to the copy tray.

- ④ Place the test pattern on the exposure glass, and then press the **[Scan Start]** key.

Limitation

- You cannot load the test pattern in the document feeder.

Note

- Set the test pattern as shown in the following illustration.

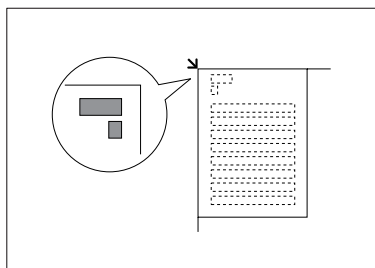

GCKAHS2J

- To return to the previous setting, and press the **[Prev. Setting]** key.

7

Do's and Don'ts

CAUTION:

- *Unplug the power cord from the wall outlet before you move the equipment. While moving the equipment, you should take care that the power cord will not be damaged under the equipment.*
- When you use this machine for a long time in a confined space without good ventilation, you may notice an odd smell. To keep the workplace comfortable, we recommend that you keep it well ventilated.
- Do not touch areas on or around the fusing unit. These areas get hot.
- After making copies continuously, you might feel the exposure glass is heated. But this is not a malfunction.
- You might feel warm around the ventilation hole. This is caused by exhaust air, and not a malfunction.
- Do not turn off the operation switch while copying or printing. Make sure that all copying or printing has finished.
- The machine might fail to produce good copy images if there should occur condensation inside caused by temperature change.
- Do not open the covers of machine while copying or printing. If you do, mis-feeds might occur.
- Do not move the machine while copying or printing.
- If you operate the machine improperly or a failure occurs on the machine, your machine settings might be lost. Be sure to take a note of your machine settings.
- Supplier shall not be liable for any loss or damages resulting from a failure on the machine, loss of machine settings, and use of the machine.

Where to Put Your Machine

Machine Environment

Your machine's location should be carefully chosen because environmental conditions greatly affect its performance.

Optimum environmental conditions

⚠ CAUTION:

- *Keep the equipment away from humidity and dust. Otherwise a fire or an electric shock might occur.*
- *Do not place the equipment on an unstable or tilted surface. If it topples over, it could cause injury.*

⚠ CAUTION:

- *If you use the equipment in a confined space, make sure there is a continuous air turnover.*

- Temperature: 10-32°C, (50-89.6°F)(humidity to be 54% at 32°C, 89.6°F)
- Humidity: 15-80% (temperature to be 27°C, 80.6°F at 80%)
- A strong and level base.
- The machine must be level within 5mm, 0.2" both front to rear and left to right.
- To avoid possible built-up ozone, make sure to locate this machine in a large well ventilated room that an air turnover of more than 30m³/hr/person.

Environments to avoid

- Locations exposed to direct sunlight or strong light (more than 2,000 lux).
- Locations directly exposed to cool air from an air conditioner or heated air from a heater. (Sudden temperature changes might cause condensation within the machine.)
- Places where the machine might be subjected to frequent or strong vibrations.
- Dusty areas.
- Areas with corrosive gases.

Power Connection

⚠ **WARNING:**

- **Only connect the machine to the power source described on the inside front cover of this manual. Connect the power cord directly into a wall outlet and do not use an extension cord.**
- **Do not damage, break or make any modifications to the power cord. Do not place heavy objects on it. Do not pull it hard nor bend it more than necessary. These actions could cause an electric shock or fire.**

⚠ **CAUTION:**

- *Unplug the power cord from the wall outlet before you move the equipment. While moving the equipment, you should take care that the power cord will not be damaged under the equipment.*

⚠ **CAUTION:**

- *When you disconnect the power plug from the wall outlet, always pull the plug (not the cable).*

- Make sure the plug is firmly inserted in the outlet.
- Voltage must not fluctuate than 10%
- The socket-outlet shall be installed near the equipment and shall be easily accessible.

Access to Machine

Place the machine near the power source, providing clearance as shown.

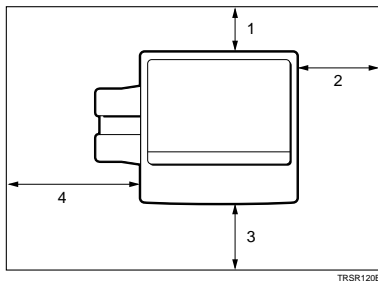

1. Rear: more than 10cm, 4.0"

3. Front: more than 55cm, 21.7"

2. Right: more than 45cm, 17.8"

4. Left: more than 48cm, 18.9"

Note

- For details about required space when options are installed, please contact your service representative.

Maintaining Your Machine

If the exposure glass, platen cover or document feeder belt is dirty, you might not be able to make copies as you want. Clean them if you find them dirty

 **Note**

- Do not use chemical cleaner or organic solvent, such as thinner or benzene. If they get into the machine or melt plastic parts, a failure might occur.
- Do not clean parts other than those specified in this manual. Such parts should be cleaned by your service representative.
- Wipe the machine with a soft, damp cloth. Then wipe it with a dry cloth to remove the water.

Exposure Glass

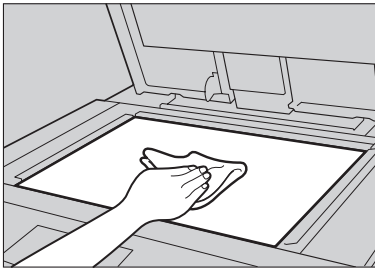

8

Platen Cover

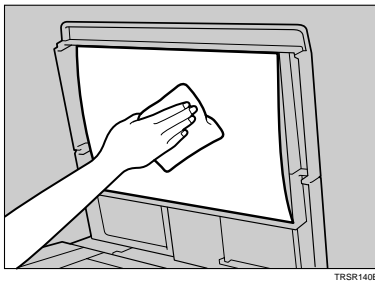

Document Feeder

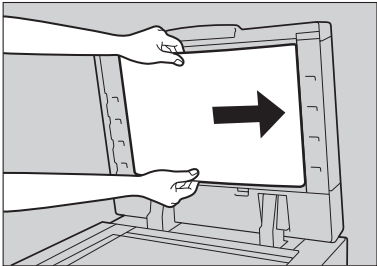

TRSR150E

Remarks

Copier

- Be careful not to move the original during the scanning process.
- To avoid problems caused by curled copies, try turning over the paper stack in the paper tray. If there is no improvement, change to copy paper with less curl.
- Load paper with the copy side down in the paper trays. If copies are curled, try turning the copy paper over in the tray. If there is no improvement, change to copy paper with less curl.
- As a default setting, narrow margins on all four sides will not be copied as shown in the illustration.

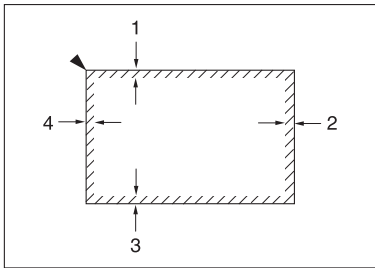

1. $2 \pm 2\text{mm}$, $0.08'' \pm 0.08''$

2. $2 \pm 2\text{mm}$, $0.08'' \pm 0.08''$ ($4 \pm 2\text{mm}$, $0.16'' \pm 0.08''$ in Thick and Extra Thick mode)

3. $2 \pm 2\text{mm}$, $0.08'' \pm 0.08''$







4. $4 \pm 2\text{mm}$, $0.16'' \pm 0.08''$

Use and Storage of Supplies

Copy Paper

- Copy paper of the types or in the conditions listed below are not recommended for this copier.
 - Folded, curled, creased, or damaged paper
 - Torn paper
 - Perforated paper
 - Paper with conductive or low electrical resistance coating such as carbon or silver coating
 - Thermal paper, art paper
 - Thin paper that has low stiffness
 - Damp paper
 - Wavy paper
 - Stapled paper
- Never use ink-jet printer paper to prevent failure.
- Use a proper type OHP transparency and place it in the correct direction.
- Fan copy paper and OHP transparencies to get air between the sheets before loading.
- Do not touch copy paper if your fingers are wet or oily; finger prints may appear on the copy.
- Load paper with the copy side down in the paper trays. If copies are curled, try turning the copy paper over in the tray. If there is no improvement, change to copy paper with less curl.
- When copying on rough surface paper, the copy image may be light.

- When setting paper thinner than $64\text{g}/\text{m}^2$, 17 lb or translucent paper in the paper trays or bypass trays, place it as shown in the figure below. The paper is divided into the vertical and horizontal types depending on the texture flow direction. If you place thin paper or translucent paper in the reverse direction, a paper jam might occur. Since A3, B4, $11" \times 17"$, and $8\frac{1}{2}" \times 14"$ sizes of thin paper are placed in the lengthwise direction in this machine, they must be of the vertical type.

	Texture flow	Setting paper in the paper trays	Setting paper in the bypass tray
Vertical type			
Horizontal type			

Paper Storage

- Paper should always be stored properly. Improperly stored paper might result in poor image reproduction, creased copies, and paper misfeeds. Generally, avoid curling and absorption of moisture.
- Avoid storing paper in humid areas. Under high temperature and high humidity, or low temperature and low humidity conditions, store paper in a vinyl bag.
- Do not store paper where it will be exposed to heat.
- Store on a flat surface.
- Use older stock first.
- Do not lay heavy objects on paper.
- Keep open reams of paper in the package, and store as you would unopened paper.

Toner Storage

- Store in a cool, dark place.
- Never store toner where it will be exposed to heat.
- Do not lay heavy objects on toner container.

Mainframe

❖ Configuration:

Console

❖ Process:

Dry electrostatic transfer system

❖ Resolution:

600 dpi

❖ Gradations:

256 gradations

❖ Originals:

Sheet, book, objects

❖ Original size:

Maximum: A3, 11" × 17"

❖ Copy paper size:

- Tray 1:

☐: A4, B5, 8¹/₂" × 11"

☐: A4, B5, A5, 8¹/₂" × 11", 8¹/₂" × 5¹/₂"

- Tray 2 and 3:

☐: A3, B4, A4, B5, 11" × 17", 11" × 15", 10" × 14", 8¹/₂" × 14", 8¹/₂" × 13", 8¹/₂" × 11", 8¹/₄" × 13", 8" × 13", 8" × 10¹/₂", 8" × 10"

☐: A4, B5, A5, 8¹/₂" × 11", 8¹/₂" × 5¹/₂"

- Bypass Tray:

⇒ P.41 "Copying from the Bypass Tray".

❖ Copy paper weight:

- Tray 1:

64 – 105g/m², 17 – 28 lb

- Tray 2 and 3

64 – 256g/m², 17 – 68 lb

- Bypass tray:

64 – 256g/m², 17 – 68 lb

- Auto Duplex Tray:

64 – 105g/m², 17 – 28 lb (When you use paper heavier than 105g/m², 28 lb, use the bypass tray and select Thick mode.)

❖ **Copy paper capacity:**

Three 500-sheet trays (Trays 1, 2, and 3)
Bypass Tray (250 sheets)

❖ **Copying speed (Full size):**

❖ **Full color (4 colors)**

	Standard mode	OHP/Thick mode	Extra Thick mode
(A4 □, 8 ¹ / ₂ " × 11" □)	13 copies/minute	5.5 copies/minute	4 copies/minute
(A3 □, 11" × 17" □)	6.5 copies/minute	2.5 copies/minute	2 copies/minute

❖ **Black, Yellow, Magenta, Cyan:**

	Standard mode	OHP/Thick mode	Extra Thick mode
(A4 □, 8 ¹ / ₂ " × 11" □)	51 copies/minute	8.5 copies/minute	5.5 copies/minute
(A3 □, 11" × 17" □)	24 copies/minute	4 copies/minute	2.5 copies/minute

❖ **Blue (Magenta + Cyan), Green (Yellow + Cyan):**

	Standard mode	OHP/Thick mode	Extra Thick mode
(A4 □, 8 ¹ / ₂ " × 11" □)	17 copies/minute	7 copies/minute	5 copies/minute
(A3 □, 11" × 17" □)	8.5 copies/minute	3.5 copies/minute	2.5 copies/minute

❖ **Red (Yellow + Magenta), Black + Cyan:**

	Standard mode	OHP/Thick mode	Extra Thick mode
(A4 □, 8 ¹ / ₂ " × 11" □)	13 copies/minute	6 copies/minute	4.5 copies/minute
(A3 □, 11" × 17" □)	6.5 copies/minute	3 copies/minute	2 copies/minute

❖ **Black + Yellow:**

	Standard mode	OHP/Thick mode	Extra Thick mode
(A4 □, 8 ¹ / ₂ " × 11" □)	17 copies/minute	7 copies/minute	5 copies/minute
(A3 □, 11" × 17" □)	8.5 copies/minute	3.5 copies/minute	2.5 copies/minute

❖ **Black + Magenta:**

	Standard mode	OHP/Thick mode	Extra Thick mode
(A4 □, 8 ¹ / ₂ " × 11" □)	16.5 copies/minute	6 copies/minute	4.5 copies/minute
(A3 □, 11" × 17" □)	8.5 copies/minute	3 copies/minute	2 copies/minute

❖ First copy time:

	Standard mode	Thick mode ^{*1}	Extra Thick mode ^{*1}
Full color (4 colors)	14 seconds or less	22 seconds or less	29 seconds or less
Black, Yellow, Magenta, Cyan	7.3 seconds or less	15 seconds or less	22 seconds or less
Blue (Magenta + Cyan), Green (Yellow + Cyan), Red (Yellow + Magenta), Black + Yellow, Black + Magenta, Black + Cyan	9.3 seconds or less	17 seconds or less	24 seconds or less

(A4, 8¹/₂"×11" , when setting an original on the exposure glass and full size copying)

^{*1} When you use the bypass tray, it takes a few more seconds.

❖ Non-reproduction area:

- Leading edge:
4±2mm, 0.16"±0.08"
- Trailing edge:
2±2mm, 0.08"±0.08" (4 ± 2mm, 0.16" ± 0.08" in Thick and Extra Thick mode)
- Side:
2±2mm, 0.08"±0.08" (Total less than 4mm, 0.16")

❖ Toner replenishment:

Cartridge (340g/cartridge)

❖ Warm-up time:

About 8.5 minutes (20°C, 68°F)

❖ Reproduction ratios:

5 enlargement and 7 reduction

	Metric version	Inch version
Enlargement	400%	400%
	200%	200%
	141%	155%
	122%	129%
	115%	121%
Full size	100%	100%

	Metric version	Inch version
Reduction	93%	93%
	82%	85%
	75%	78%
	71%	73%
	65%	65%
	50%	50%
	25%	25%

❖ **Power consumption:**

	Copier only	Full system ^{*1}
Warm up	1.7kW	1.7kW
Stand-by	0.6kW	0.6kW
During printing	1.50kW	1.50kW
Maximum	less than 1.75kW	less than 1.75kW

^{*1} Full system: Mainframe with the document feeder, 20-bin sorter stapler and large capacity tray.

❖ **Noise Emission ^{*1}:**

❖ **Sound power level**

	Mainframe only	Complete System ^{*3}
Stand-by	less than 52 dB (A)	less than 54 dB (A)
During printing	less than 69.9 dB (A)	less than 72 dB (A)

❖ **Sound pressure level ^{*2}**

	Mainframe only
Stand-by	less than 37 dB (A)
During printing	less than 55.1 dB (A)

^{*1} The above measurements that are made in accordance with ISO 7779 are the actual values.

^{*2} It is measured at the position of the operator.

^{*3} The Complete System consists of Mainframe, Document Feeder, Sorter Stapler and Large Capacity Tray.

❖ **Dimensions (W × D × H up to the exposure glass):**

750 × 780 × 980mm, 29.6" × 30.8" × 38.6"

❖ **Weight:**

Approx. 245kg, 540.2 lb

 **Note**



□ Specifications are subject to change without notice.

Document Feeder (Option)

❖ Original Feed:

Automatic reverse document feed - ARDF mode
 Automatic document feed - ADF mode
 Semi-automatic document feed - SADF mode

❖ Original size:

A3  - B6   (B6   cannot be used in ARDF mode)
 11" × 17"  - 5¹/₂" × 8¹/₂"  

❖ Original weight:

- SADF mode, ADF mode:
52 - 128g/m², 14 - 34 lb
- ARDF mode:
52 - 105g/m², 14 - 28 lb

(For 40 - 52g/m², 11 - 14 lb originals, use ADF Thin Paper mode. B6  cannot be used in ARDF Thin Paper mode)

❖ Maximum number of originals to be set:

50 sheets (80g/m², 20 lb)

❖ Original set:

Face up, First sheet on top

❖ Original transport:

One flat belt

❖ Maximum power consumption:

45W (Power is supplied from the main frame.)

❖ Weight:

Less than 10.5kg, 23.2 lb

❖ Dimensions (W × D × H):

610 × 507 × 130mm, 24.1" × 20.0" × 5.2"

Note

- Specifications are subject to change without notice.

20-bin Sorter Stapler (Option)

◆ Number of bins:

20 bins + proof tray

◆ Paper size for bins (Normal mode):

- Proof tray:
A3, B4, A4, B5, A5, 13" × 19", 12" × 18", 11" × 17",
11" × 15", 10" × 14", 8¹/₂" × 14", 8¹/₂" × 13", 8¹/₂" × 11",
8¹/₂" × 5¹/₂", 8¹/₄" × 13", 8" × 13", 8" × 10¹/₂", 8" × 10"
- Sort/Stack:
A3, B4, A4, B5, 11" × 17", 11" × 15", 10" × 14",
8" × 10", 8" × 10¹/₂", 8¹/₂" × 14", 8¹/₂" × 13", 8¹/₄" × 13",
8" × 13", 8¹/₂" × 11", 12" × 18", 13" × 19"
- Staple:
A3, B4, A4, B5, 11" × 17", 11" × 15", 10" × 14",
8¹/₂" × 14", 8¹/₂" × 13", 8¹/₄" × 13", 8" × 10", 8" × 10¹/₂",
8" × 13", 8¹/₂" × 11", 12" × 18", 13" × 19"

◆ Paper weight for bins:

- Proof tray:
64g/m² - 105g/m², 17 - 28 lb
- Sort/Stack:
64g/m² - 256g/m², 17 - 68 lb
- Staple:
64g/m² - 256g/m², 17 - 68 lb

◆ Bin capacity (Normal mode):

- Sort:
50 sheets (80g/m², 20 lb)
- Stack:
50 sheets (80g/m², 20 lb)

◆ Stapler capacity (Normal mode):

2-50 sheets (80g/m², 20 lb)

◆ Proof tray capacity:

250 sheets/A4 or smaller (80g/m², 20 lb)
200 sheets/B4 or larger (80g/m², 20 lb)

◆ Maximum power consumption:

60W (Power is supplied from the main frame.)

◆ Weight:

65kg, 143.3 lb

❖ **Dimensions (W × D × H):**

600 × 615 × 980mm, 23.7" × 24.3" × 38.6"

 **Note**

Specifications are subject to change without notice.

Large Capacity Tray (LCT) (Option)

❖ **Paper size:**

A4 □, 8¹/₂" × 11" □

❖ **Paper weight:**

64 - 105g/m², 20 - 28 lb

❖ **Paper capacity:**

1,500 sheets (80g/m², 20 lb)

❖ **Power consumption:**

Approx. 40W (power is supplied from the main frame.)

❖ **Dimensions (W × D × H):**

390 × 500 × 390mm, 15.4" × 19.7" × 15.4"

❖ **Weight:**

Approx. 17kg, 37.5 lb

Multi-access

You can carry out another job using a different function while the current job is being performed.

This allows you to handle your jobs efficiently regardless of how the machine is being used. For example:

- The machine can receive print data in any mode.

Performing multiple functions simultaneously like this is called Multi-access.

Limitation

- You cannot use Multi-access during Interrupt copying.

Note

- You can choose which mode has highest priority for printing jobs. The default is "Copy". See "Interleave Print" in ⇒ P.213 "System settings".

Sample operations

This chart is based on the following conditions:

- “Interleave Print” is set to “On” (See “Interleave Print” in ⇒ P.213 “System settings”).
- For details on operations under other conditions, contact your service representative.

Mode after you select		Copy				Printer				Scanner		
		Operating	Copying	Sort	Stapling	Data Reception	Print			Stand by	Scanning	
							Printing	Sort	Stapling			
Current job functions												
Copy	Operating	○ ^{*1}	○ ^{*1}	✗	✗	☆	☆	☆	☆	* ⁵	* ⁵	
	Copying	○	○	✗	✗	☆	* ⁴	* ⁷	* ⁷	✗	✗	
	Sort	○	○	✗	✗	☆	☆	* ³	* ³	✗	✗	
	Stapling	○	○	✗	✗	☆	☆	* ³	* ³	✗	✗	
Printer	Data Reception	☆	☆	☆	☆	→	→	→	→	✗	✗	
	Print	Printing	☆	* ⁴	* ²	* ²	☆	→	* ⁷	* ⁷	✗	✗
		Sort	☆	☆	✗	✗	☆	→	* ³	* ³	✗	✗
		Stapling	☆	☆	✗	✗	☆	→	* ³	* ³	✗	✗
Scanner	Stand by	* ⁶	* ⁶	* ⁵	* ⁵	→	→	→	→	✗	✗	
	Scanning	✗	✗	✗	✗	→	→	→	→	✗	✗	

☆...means that these functions can be used together.

○...means that you can interrupt the current job with Function keys or the **[Interrupt]** key to proceed to a subsequent job.

→...means that another job will automatically start after the current job is finished.

✗...means that you must manually start another job after the current job is finished (i.e. these functions cannot be used together).

*¹ When you operate Area Editing or Image Overlay, this is not available.

*² When you copy onto thick or extra thick paper, this is not available.

*³ When paper is left in the optional 20-bin sorter stapler, remove it, or the next operation cannot be performed.

*⁴ Both operations are performed concurrently and output is interleaved.

*⁵ When you press the **[Printer/Scanner]** key, the next operation to be performed is available.

*⁶ When you press the **[Interrupt]** key, the next operation to be performed is available.

*⁷ When you copy onto thick or extra thick paper, see *³.

INDEX

1 Sided → 2 Sided, 69
20-bin sorter stapler, 6
2 Sided → 1 Sided, 78
2 Sided → 2 Sided, 72

A

A.C.S. (Auto Color Selection) Sensitivity, 142
Adding Areas, 178
Adding Staples, 201
Adjusting Copy Image Density, 28
Area Editing, 167
Area Shapes, 156, 172
Auto color select mode, 30
Auto duplex tray, 4
Auto image density, 28
Auto Off Mode, 52
Auto original type select mode, 36
Auto paper select, 39
Auto Reduce/Enlarge, 51
Auto Start, 54

B

Background Density, 142
Basic Settings, 130
Black & White copy mode, 31
Book → 1 Sided, 76
Book → 2 Sided, 73
Border Erase, 86
Bypass tray, 5

C

Center/Border Erase, 87
Center Erase, 86
Change Modes, 176
Changing Basic Settings for the Entire Image, 174
Changing Paper Size, 207
Changing The Toner Cartridge, 196
Checking and Changing Areas, 176
Check Modes, 57
Clearing Misfeeds, 198
Color Adjustment, 140
Color Background, 97
Color Balance, 131
Color Balance Adjustment, 131

Color Balance Program, 132
Color Balance Sample, 134
Color Conversion, 94
Color Creation, 94
Color Erase, 96
Color Sample Chart, 11
Combination Chart, 121
Combination Chart for Area Editing, 182
Combine, 79
Combine 2 Originals, 79
Combine 4 Originals, 81
Combined auto and manual image density, 29
Contrast, 142
Copying from the Bypass Tray, 41
Copy tray, 5
Counter, 57
Cover Sheet, 89

D

Delete Area, 168
Designate Area Display, 154
Designate Area Tools, 155
Designating Areas, 153
Directional Magnification (%), 63
Directional Size Magnification (inch), 64
Document feeder (ADF), 6
Do's and Don'ts, 227
Duplex, 69

E

Edit Background, 128
Energy Saver Mode, 52
Erase, 86
Erasing a Group, 180
Erasing an Area, 179
Exiting Area Editing, 181
Exposure glass, 4

F

Finishing, 116
Frame/Line, 160
Front & Back Cover, 91
Front Cover, 89
Front cover, 4
Full color copy mode, 30

H

How to Edit Areas, 152

I

Image Adjustment, 142
Image Creation, 101
Image Overlay, 125
Interrupt Copying, 53

L

Large capacity tray (LCT), 6
Loading a Stack of Originals in the Document Feeder, 19
Loading one Original at a Time in the Document Feeder, 21
Loading Originals of Different Sizes in the Document Feeder, 23
Loading Paper, 192

M

Main power switch, 5
Maintaining Your Machine, 230
Manual image density, 29
Manual paper select, 40
Margin Adjustment, 83
Mirror Image, 108
Multi-access, 243
Multi → 2 Sided, 74

N

Notes for Designating Areas, 163

O

Operation Panel, 7
Operation switch, 4
Options, 6
Originals, 16
Original tray, 6
Outline Image, 101

P

Paper tray, 4
Pastel, 142
Photo mode, 38
Placing Custom Sized Originals, 24
Placing Originals on the Exposure Glass, 18
Platen cover, 4
Positive/Negative, 114
Poster Mode, 66
Preset R/E, 58
Program, 55
Program User Color, 145

R

Recall, 54
Reduce/Enlarge, 58
Remarks, 232
Removing Jammed Staples, 203
Removing the Platen Cover to Copy a Large Original, 26
Repeat Image, 109
Right side cover/Lower right cover, 5

S

Safety Information, ii
Save Area, 169
Selecting a Color Mode, 30
Selecting Modes for Designated Areas, 165
Selecting Modes for Outside Designated Areas, 171
Selecting the Copy Paper Size, 39
Selecting the Original Image Type, 36
Series Copies, 76
Shadow Image, 102
Shift, 82
Shifting the Image, 82
Single color mode, 31
Size Magnification, 61
Slanted Image, 106
Soft/Sharp, 142
Sort, 116
Special original mode, 38
Specification, 235
Stack, 117
Staple, 118
Stopper, 5

T

Text mode, 37
Text/Photo mode, 36
Text/Photo Sensitivity, 142
Twin Color Mode, 34
Type Mask, 99

U

U.C.R. Adjustment, 142
User Tools, 211
Using the Touch Panel Display, 9

V

Ventilation hole, 5

W

What You Can Do with This Machine, 2
Where to Put Your Machine, 228

Z

Zoom, 60



Customer Vision® –
our commitment to your
complete satisfaction



your document management partner

www.lanier.com

Lanier Worldwide, Inc. | 2300 Parklake Drive, N.E. | Atlanta, GA USA 30345

T1202-6001